

MEISTER

**Flooring
Installation and
Care Instructions**



MEISTER Flooring Installation and Care Instructions

Contents

General information before installation for all MEISTER flooring	6
Preparatory measures, subfloors and general instructions	6
Parquet flooring, Lindura wood flooring and wood flooring Natureflex	8
Parquet flooring and Lindura wood flooring with Mastercllic Plus technology	8
Parquet flooring and Lindura wood flooring with UniZip technology	10
Parquet flooring and wood flooring Natureflex with Multiclic technology	12
Parquet flooring and Lindura wood flooring on walls	14
Meister Parquet. longlife PD 450, PD 400, PC 200 and Lindura® wood flooring HD 400 with Mastercllic Plus technology	14
Design and laminate flooring	16
Design with Mastercllic Plus technology	16
Laminate flooring with 5G™ Dry™ technology	18
Laminate flooring with UniZip technology	20
Laminate flooring with Multiclic technology	22
Meister Design. flex with Multiclic technology	24
Meister Design. rigid and Meister Design. allround with Multiclic technology	26
Installation in humid rooms	28
Briefing sheet: home conservatories / floor-to-ceiling windows	29
Skirting boards and accessories	30
Flooring profiles	30
Wall transitions / skirting boards	32
Underlay materials	33
Installation on hot-water underfloor heating structures	34
Parquet flooring	34
Lindura wood flooring	35
Wood flooring Natureflex	36
Design flooring	37
Laminate flooring	38
Installation on hot-water underfloor heating structures with cooling function	39
Installation over electrical underfloor heating systems	40
Full-surface bonding	41
Parquet flooring, Lindura wood flooring and wood flooring Natureflex	41
Meister Design. pro design flooring	42
Cleaning and care instructions	43
Warranty conditions	47

Quality starts with the
installation.



For us, MEISTER quality is not just about the durability of your floor. It can also be seen during the installation of your floor. We use click systems, which are tailored to the properties of the flooring and dimensions of the planks. This ensures optimal precision of fitting that you can feel while installing your

new flooring. MEISTER flooring is especially easy to install. That's why many craftsmen swear by products from MEISTER. You will find a lot of information about how to work with your MEISTER product in these installation and care instructions.



Preparatory measures, subfloors and general instructions

Before opening the packages, leave them to acclimatise until they have adjusted to room temperature. Store them unopened and lying flat on the ground for approx. 48 hours (in winter 3–4 days) (Fig. 1) / MeisterDesign. allround, MeisterDesign. rigid and MeisterDesign. pro for approx. 24 hours (in winter 2 days) (Fig. 1.1) in the centre of the room you want to work in. Do not store the packages in front of damp or freshly wallpapered walls. Before you install the flooring, outer doors and windows must be installed and all painting and decorating work must be finished. The room temperature must be approx. 20° C (subfloor at least 15° C), and the relative humidity must be approx. 30–65 per cent.

Parquet and wood flooring are primarily made of wood. Their special product structure and click connection technology allow MEISTER parquet, Lindura wood flooring and wood flooring Natureflex to be laid floating and without glue. As a natural raw material, wood has properties that continue to be present when used in wood flooring. Sunlight and even intense artificial light can cause it to change in colour. Wood also has hygroscopic properties, which means it can absorb (and release) moisture and reacts with swelling (and shrinkage). If the relative humidity in the room is very low, for example, and the parquet or wood flooring shrinks, this can lead to slight cracks in the top layer, joint formation, deformation, creaking noises, or similar. This is all considered normal within the scope of typical wood properties and therefore does not represent a defect in the product. Before installation, check all planks in daylight for recognisable faults and damage, as well as colour and structure (Fig. 14). Arrange the planks before laying so that you achieve the flooring pattern and colour you want (Fig. 15). You cannot make a claim for any products you have already installed.

The subfloors must be considered ready-to-lay in accordance with the generally accepted rules of technology, taking into account VOB (German Construction Contract Procedures) Part C, DIN 18356 'Laying of parquet' or DIN 18365 'Flooring works' respectively. They must therefore be dry, even, solid and clean. The residual humidity, measured using the CM method, of mineral subfloors / construction site screed must be no more than 2 CM per cent (1.8 CM per cent for underfloor heating) and that of anhydrite screeds must be a maximum of 0.5 CM per cent (0.3 CM per cent for underfloor heating). The limit values when carrying out the CRH method are 80 per cent relative humidity for unheated screeds and 75 per cent relative humidity for heated screeds (TKB briefing sheet 18; DIN EN 17668) (Fig. 4). For installation over underfloor heating systems or underfloor heating systems with cooling function, separate briefing sheets are available from page 34 onwards. Any subfloor unevenness of three or more millimetres for each initial metre and two or more millimetres for each

subsequent continuous metre must be evened out according to DIN 18 202, table 3, line 4 (Fig. 2). We recommend consulting technical information sheet 02 from the Zentralverband für Parkett und Fußbodentechnik (Central Association for Parquet Flooring and Flooring Technology) and the BEB (German Federal Association of Screed and Floor Covering). For MeisterDesign. rigid and MeisterDesign. allround, joints in old ceramic subfloors wider than 10 mm and more than 2 mm deep (Fig. 3) must be levelled using suitable filler materials. A moisture protection film (SD value ≥ 75 m) must be laid out on all mineral subfloors (except poured asphalt screed) as a moisture-resistant barrier (Fig. 5). The strip edges must overlap by at least 20 cm and the overlapping edges must be masked off at the sides. Alternatively, you can use MEISTER insulating underlay with an integrated moisture-resistant barrier. A moisture-resistant barrier is not required for waterproof MeisterDesign. allround and MeisterDesign. rigid. In rooms that are not above a cellar, the currently valid building conditions require that the owner of the building provide a barrier against damage to the base plate due to moisture from the ground, in accordance with DIN 18195.

MEISTER flooring can be laid on existing surfaces, such as ceramic tiles and boards or stone floors, so long as the old flooring is firmly bonded and there are no loose areas. You should also spread out a moisture protection film (SD value ≥ 75 m) on these subfloors as a separating layer (Fig. 6). Do not use a moisture-resistant barrier on existing PVC, wooden planks, wood-based boards, OSB boards, prefabricated screed, etc. (Fig. 6.1). Textile flooring such as carpet or needle fleece must be removed not only for technical reasons, but also for hygiene reasons (Fig. 6.2).

MEISTER flooring is not suitable for installation in humid rooms / wet areas (bathrooms, saunas, swimming pools, etc.).
Exception: The MeisterDesign. flex, MeisterDesign. comfort, MeisterDesign. next, Lindura wood flooring HD400, wood flooring Natureflex HD 100, MeisterParquet. longlife PD 450, PD400, PS 300, PC 200, laminate floorings LC 150, LD 150, LB 150, LL 150, LD 200, LD 250, LL 250 and LS 350 as well as the MeisterDesign. allround, MeisterDesign. rigid, and MeisterDesign. pro waterproof design floorings can all be installed in humid rooms (Class W0-I, e.g. bathrooms; Class W1-I for life and pro). They are not suitable for installation in outdoor areas or wet rooms such as showers, saunas, public washrooms or rooms with a floor drain (Fig. 9) – separate briefing sheet, see page 28.

All MEISTER floorings are suitable for installation in home conservatories (Fig. 10). Shading and ventilation systems must be used to avoid strong sunlight and prevent the flooring from heating up. It is important to maintain a suitably consistent temperature for the living space all year round.

The surface temperature of the floor must not permanently exceed 29°C – separate briefing sheet, see page 29.

With all floating MEISTER flooring, we recommend installing any heavy objects or fitted furniture (such as kitchens or kitchen islands) prior to laying the flooring and only laying it up to just below the skirting (Fig. 11).

The MEISTER flooring is generally installed floating, without glue. If you want to glue down your floating parquet, Lindura wood flooring or wood flooring Natureflex, particularly to minimise the possible creaking noises and joint formation described above, please refer to the separate briefing sheet on this (Fig. 13). You can request this from kundenservice@meisterwerke.com.

MeisterDesign. pro flooring is exclusively intended for full-surface bonding. MeisterParquet. longlife, Lindura wood flooring and wood flooring Natureflex can also be installed with full-surface bonding using an approved adhesive as an alternative to floating installation (Fig. 12) – separate briefing sheet, see pages 41–42.

If the floor area is longer or wider than 10 metres (Fig. 7) (or longer or wider than 12 m for MeisterDesign. allround or laminate LL 250 and LD 250 (Fig. 7.1), or longer or wider than 15 metres for MeisterDesign. rigid (Fig. 7.2)) then you must provide an expansion joint. Cover this with a transition profile. It is also important to provide these joints between two adjacent rooms, in doorways (Fig. 8), passageways and rooms with a lot of angles (MeisterDesign. rigid and MeisterDesign. allround can be installed in doorways without transition profiles. Expansions joints from the subfloor must be incorporated).

Always use a jointing profile for clean transitions to adjacent, lower areas or floor coverings and an end profile next to higher adjacent thresholds, tiles or similar. Give stairs a clean finish with the stair edge profile (see pages 30–31).

To protect the wood from dirt, a sufficiently large entrance covering must always be laid (such as a doormat) (Fig. 16). Do not use any rubber-coated mats, since prolonged contact can lead to permanent discolouration, especially in design flooring. In addition, you should also fit chair and furniture feet with felt sliders; office chairs, mobile containers, etc., on castors must be equipped with soft, standard running surfaces (type W) (Fig. 17). Coloured rubber, natural rubber or plastic glides and castors as well as dark car, bike or equipment tyres may possibly cause discolouration on design flooring. Please only use light, non-migrating furniture glides, castors or tyres, if possible. We recommend protecting MeisterParquet. longlife, Lindura wood flooring and wood flooring Natureflex in these heavy-wear areas with appropriate floor protection mats (e.g. polycarbonate mats) (Fig. 17.1).

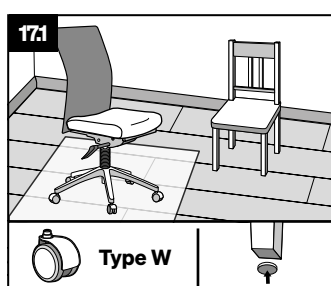
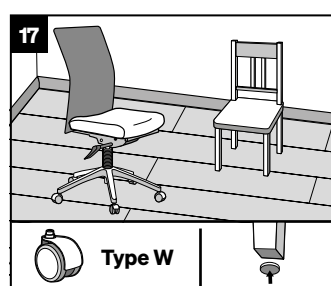
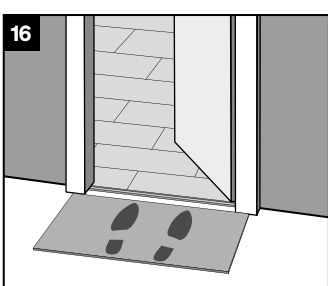
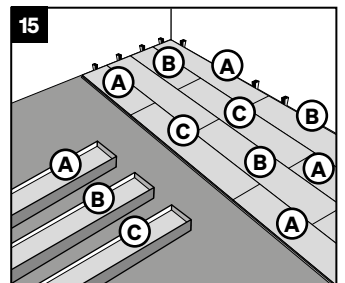
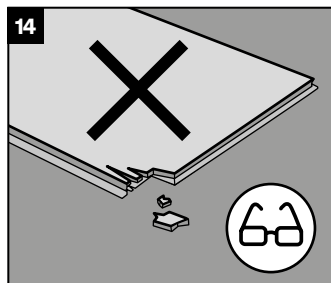
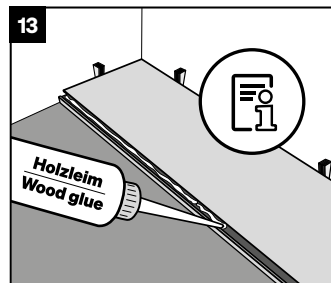
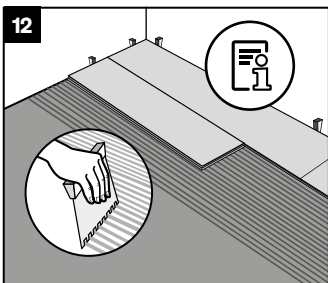
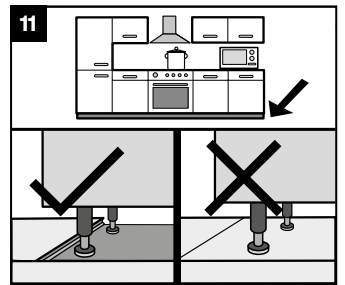
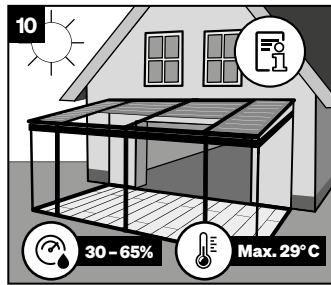
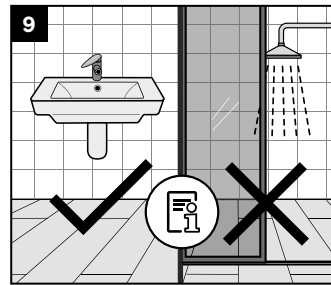
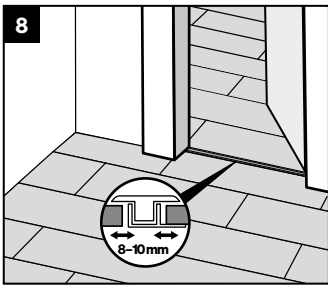
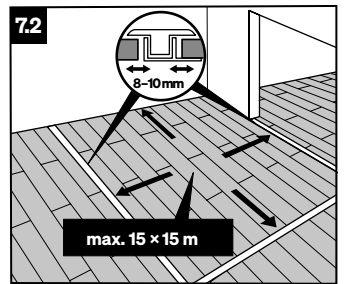
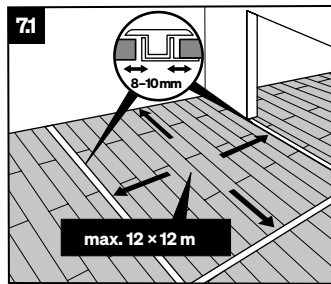
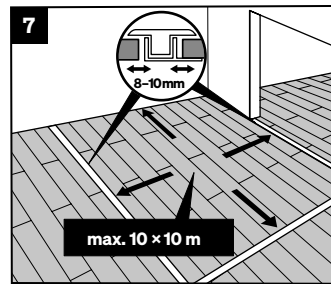
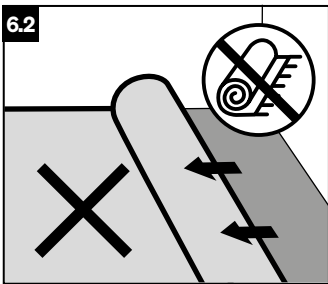
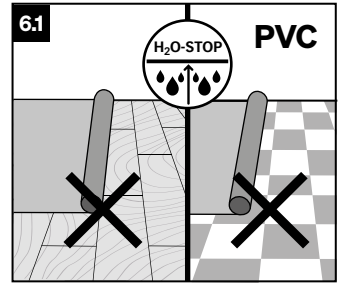
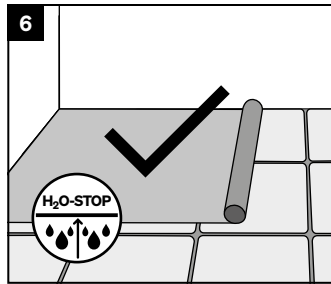
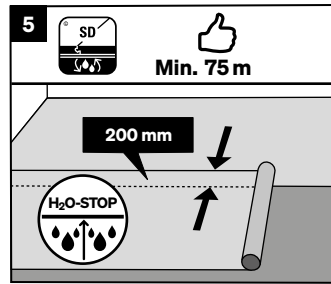
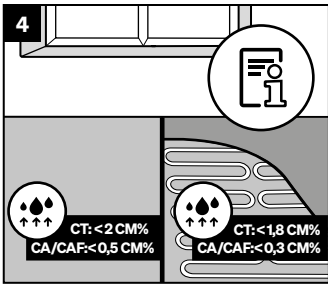
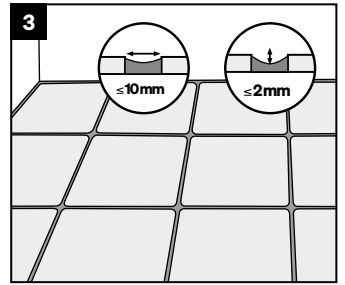
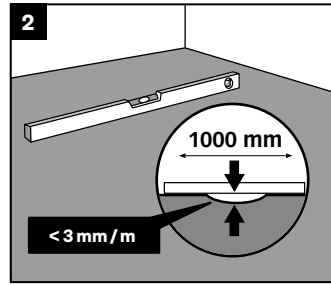
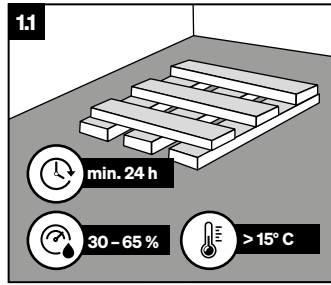
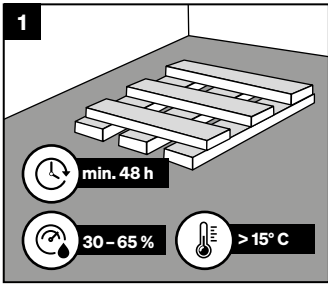

Parquet flooring and Lindura wood flooring with Mastercllic Plus technology



Fig. A1 + A2 + A3

The flooring is generally installed as a floating structure without glue. The Mastercllic Plus connection system makes it possible to install the flooring quickly and easily. The short-end interlocking occurs when the next row is laid.

TIP: Manually lock the Mastercllic Plus at the short end (activating the plastic tongue) with a short piece of plank.

This also makes for a valuable installation aid, as the planks can be aligned against each other in this way. To do this, you should lift the plank slightly and simply square it with the tongue in the groove of the plank that has already been laid.

Fig. 1

The following tools and aids are required to install MeisterParquet, longlife and Lindura wood flooring with Mastercllic Plus technology:

Hammer, keyhole or electric saw (**for Lindura wood flooring: hard metal saw blades or diamond tipped saw blades**), possibly power drill, folding metre rule, pencil, wedges (spacer wedges), heel bar, angle or adjustable bevel, possibly moisture protection film (SD value ≥ 75 m). If you are using products without sound-absorbing Silence cushioning, use the system-specific MEISTER insulating underlay. Any other insulating underlay must have a suitable pressure stability (CS value ≥ 15 kPa).

Fig. 2

Remove any dirt, small stones, etc. from the surface prior to installation.

Fig. 3

A moisture protection film must be laid out to form a 'bath' on all mineral subfloors (except poured asphalt screed) as a moisture-resistant barrier. The strip edges must overlap by at least 20 cm and the overlapping edges must be masked off. Alternatively, the option is available to use MEISTER insulating underlay with an integrated moisture-resistant barrier.

Fig. 4

Lay the corresponding MEISTER insulating underlay with a pressure resistance of >15 kPa.

Fig. 5

Before installation, check all planks in daylight for recognisable faults in colour and structure. No claims can be made for goods that have already been installed.

Fig. 6

Install a mixture of planks from different packages.

Fig. 7

When sawing the elements, make sure you work from the correct side: if you use a bench saw, keep the decorative side facing up, if you use a keyhole or portable circular saw, keep the decorative side down.

Start by laying the first complete plank in the left-hand corner of the room with the tongue sides facing the wall. Remove only the tongues on the long sides of all the other planks you want to lay in the first row. Using wedges, you can easily keep a gap of at least 15 mm from the wall.

Fig. 8

Insert the head end of the next complete plank into plank 1. Install the other planks in this row in exactly the same way across the entire width of the room.

Fig. 9

The last planks in each row are cut to size so that a gap of at least 15 mm to the wall is taken into account. You can use cut-off pieces of planks to start subsequent rows.

Fig. 10

Make sure that the planks in the first row are straight. Cut the first plank of the second row down to approx. 80 cm. Angle this plank flat with the tongue as far as possible into the groove side of the previous row of planks and press the plank down slowly using a forward and downward turning motion. The plank should click into the previously installed row.

TIP: Activate the plastic tongue in the previous row at the short end with a short piece of plank (Fig. A3).

Fig. 11

Similarly, the next complete plank is turned into the click connection on the long side and the head end pushed tight against the previous plank before it is lowered. Then press the plank down slowly using a forward and downward turning motion. The plank has to click into the previously installed row and the short-end joint with the previous plank has to be closed.

Fig. 12

Continue the installation row by row in this way. Remember that the short-end joints must always be offset by at least 30–40 cm.

Fig. 13 + Fig. 14

The last planks in each row are cut to size so that a gap of approx. 15 mm to the wall is taken into account. Lay the plank with the tongue side facing the wall to mark the remaining plank width.

Fig. 15

Taking the plank marked for width, push the plastic tongue at the short end forward out of the end groove using the spare piece of plank.

Fig. 16

Begin cutting the plank to size at the short end of the plastic tongue.

Fig. 17

After the plank has been cut to size, push the plastic tongue at the short end back into the end groove. Start by laying the last row in the right-hand corner of the room (leaving at least a 15 mm gap to the wall) and angle the long side of the plank into the second-last row. The next plank is angled in the same way and lowered down at the short end.

Fig. 18

Push the plastic tongue that is pointing out towards the wall back into the short-end connection using a heel bar, scraper, screwdriver or similar.

Fig. 22

Next, remove the wooden wedges from around the walls.

Fig. 23

Screw the skirting board clips to the wall at intervals of 40–50 cm. To ensure that the skirting board fits tightly, do not position it on an uneven wall.

Fig. 24

The skirting board is placed on the clip from above and pressed down. For the length joints of the skirting boards, the clip is placed on the joint with a half overlap to ensure a good hold.

Please avoid bringing any silicone products into contact with the skirting boards.

Fig. 19 – Fig. 21

To take a plank row back out again, lift the entire row, levering it at the side out of the last row. You can then slide the planks apart at the short ends. Should you wish to reuse the disassembled planks, you should first push the plastic tongue at the short end back into the top groove so it sits flush.

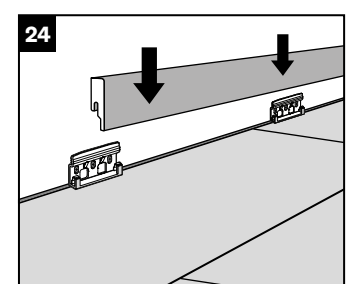
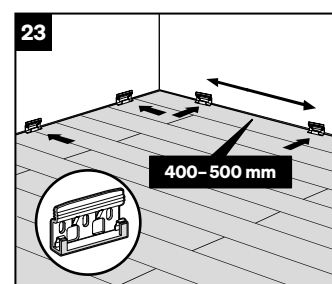
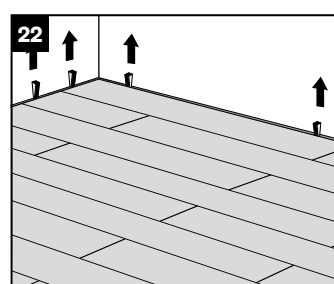
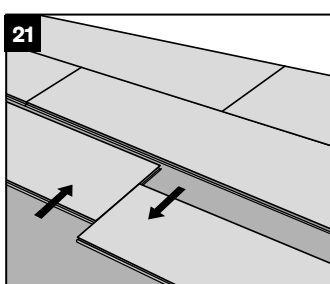
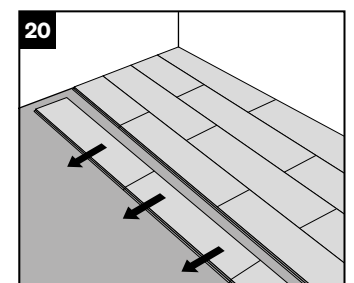
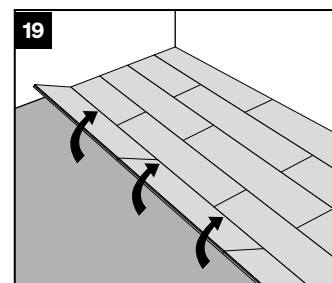
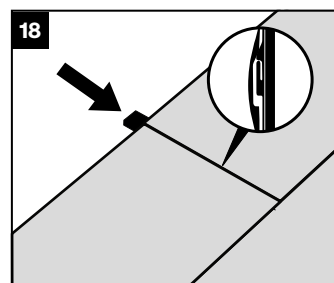
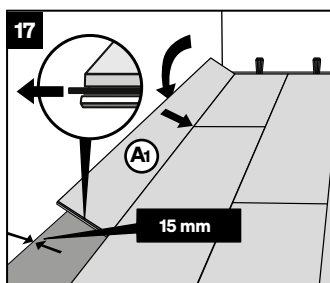
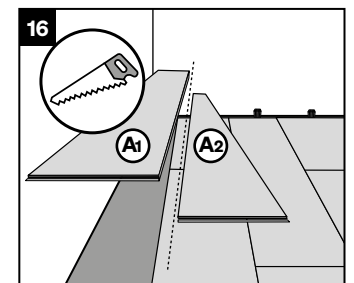
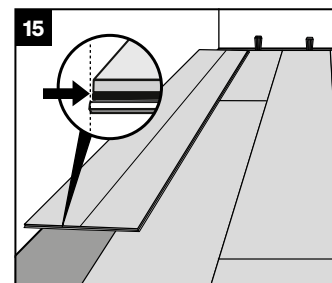
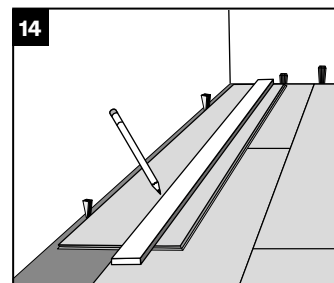
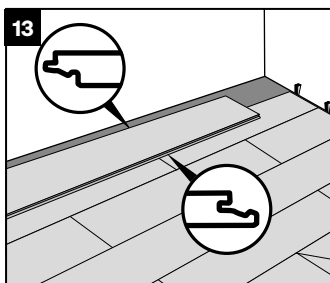
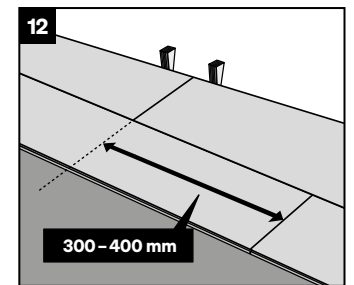
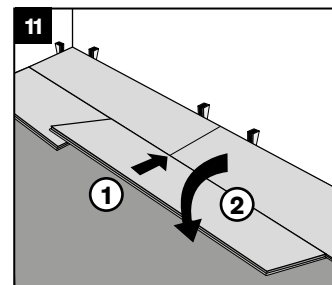
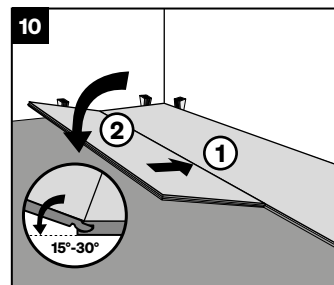
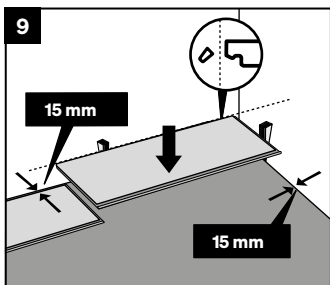
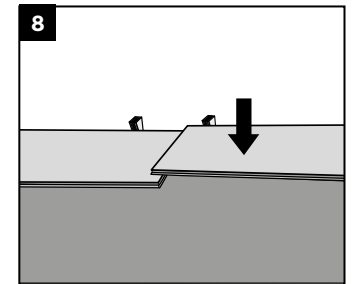
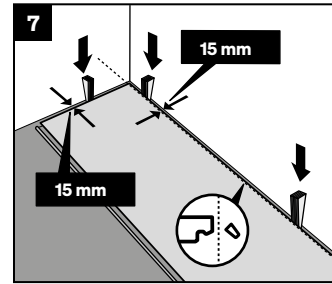
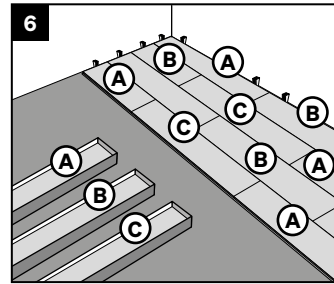
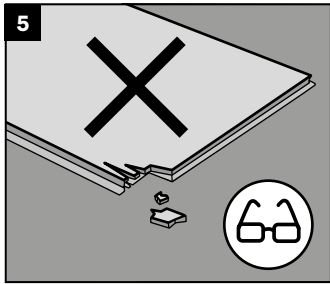
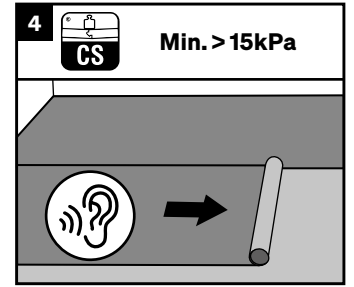
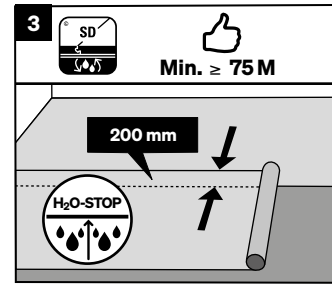
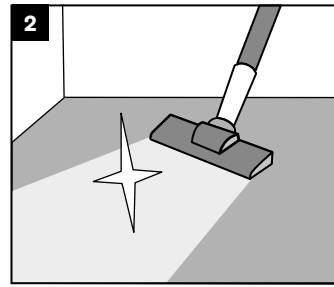
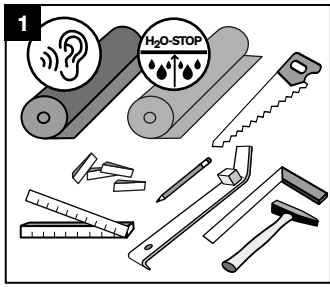
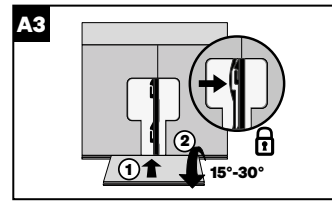
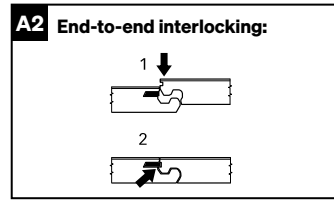
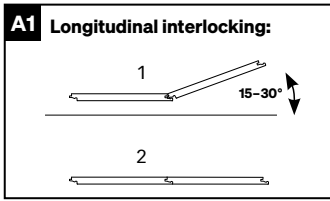

Parquet flooring and Lindura wood flooring with UniZip technology



Fig. 1

The following tools and aids are required to install MeisterParquet, longlife and Lindura wood flooring with UniZip technology:

Hammer, keyhole or electric saw (**for Lindura wood flooring, use carbide or diamond-tipped saw blades**), possibly power drill, folding metre rule, pencil, MEISTER tapping block, wedges (spacer wedges), heel bar, angle or adjustable bevel, possibly moisture protection film (SD value ≥ 75 m). If you are using products without sound-absorbing Silence cushioning, use the system-specific MEISTER insulating underlay. Any other insulating underlay must have a suitable pressure stability (CS value ≥ 15 kPa).

Fig. 2

Remove any dirt, small stones, etc. from the surface prior to installation.

Fig. 3

A moisture protection film must be laid out to form a 'bath' on all mineral subfloors (except poured asphalt screed) as a moisture-resistant barrier. The strip edges must overlap by at least 20 cm and the overlapping edges must be masked off. Alternatively, the option is available to use MEISTER insulating underlay with an integrated moisture-resistant barrier.

Fig. 4

Lay the corresponding MEISTER insulating underlay with a pressure resistance of >15 kPa.

Fig. 5

Before installation, check all planks in daylight for recognisable faults in colour and structure. No claims can be made for goods that have already been installed.

Fig. 6

Install a mixture of planks from different packages.

Diagonal herringbone pattern (option 1)

Fig. 14

Draw a guide line using chalk to ensure a uniform distance to all walls.

Fig. 7

Start the installation in a corner of the room. Saw the tongues off the first plank, both on the short and the long side.

Fig. 8

Using wedges, you can easily keep a gap of 10–15 mm from the wall. On the second plank, only the tongue on the long side has to be cut off.

Fig. 9

Now angle the head end of the second plank into the long side of the first plank.

Fig. 10 + Fig. 11

Then angle the long side of the third plank into the first plank. Now interlock the short end of

the third plank into the second plank using the MEISTER tapping block.

Fig. 12 – Fig. 14

Follow this process to continue the installation. Make sure that the long sides of the planks are angled in first before interlocking the short ends.

Fig. 15

Lay the first zigzag as far as the wall/corner of the room. The leftover pieces of planks there can possibly be used at the start of the next row. The first zigzag has to be fixed with wedges so that the braid does not slide during the rest of the installation.

Fig. 16 + Fig. 17

Before starting the next row, check if there are any leftover pieces that could be used. Over the course of the installation, make sure that the long sides of the planks are angled in first before interlocking the head ends.

In certain situations, it is not possible to angle in the long side first before interlocking the head end. The special connection technique allows the plank to be interlocked in any conceivable direction, meaning the head end can be angled in first and the element can be interlocked via the long side, for example.

Install the entire area up to the end of the room in this sequence. The planks that end at the wall are cut to size so that a gap of 10–15 mm to the wall is taken into account.

Parallel herringbone pattern (option 2)

Fig. 18

Draw a guide line using chalk to ensure a uniform distance to opposite walls. Start the installation in the middle of the room facing a wall. To ensure the installation is symmetrical, the installation line must be shifted by $\frac{1}{4}$ of the mitre width (PS 500: 50.2 mm; HS 500: 49.5 mm) from the centre of the room.

Fig. 9

Angle the head end of the second plank into the long side of the first plank.

Fig. 10 + Fig. 11

Then angle the long side of the third plank into the first plank. Now interlock the short end of the third plank into the second plank using the MEISTER tapping block.

Fig. 18

Follow this process to continue the installation as far as the sixth plank. Align the planks with the installation line and cut them parallel to the wall. You can now align the short, head end (in the shape of a triangle) at an even distance of 10–15 mm from the wall along the installation line and fix it in place with wedges. Make sure that the long sides of the planks are angled in first before interlocking the short ends.

Fig. 19

Lay the first zigzag as far as the opposite wall. The leftover pieces of planks there can possibly be used at the start of the next row. The first zigzag has to be fixed with wedges so that the braid does not slide during the rest of the installation.

Fig. 20 + Fig. 21

Before starting the next row, check if there are any leftover pieces that could be used. Over the course of the installation, make sure that the long sides of the planks are angled in first before interlocking the head ends.

In certain situations, it is not possible to angle in the long side first before interlocking the head end. The special connection technique allows the plank to be interlocked in any conceivable direction, meaning the head end can be angled in first and the element can be interlocked via the long side, for example.

Install the entire area up to the end of the room in this sequence. The planks that end at the wall are cut to size so that a gap of 10–15 mm to the wall is taken into account.

Fig. 22

Next, remove the wooden wedges from around the walls.

Fig. 23

Screw the skirting board clips to the wall at intervals of 40–50 cm. To ensure that the skirting board fits tightly, do not position it on an uneven wall.

Fig. 24

The skirting board is placed on the clip from above and pressed down. For the length joints of the skirting boards, the clip is placed on the joint with a half overlap to ensure a good hold. Please avoid bringing any silicone products into contact with the skirting boards.

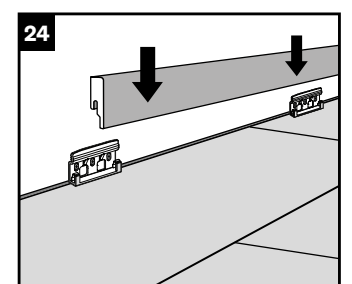
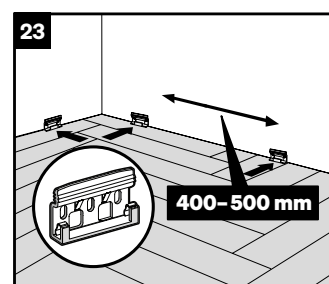
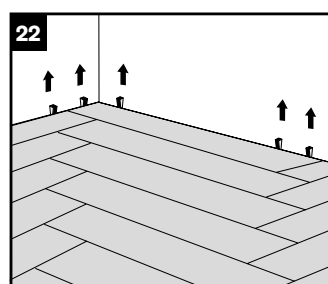
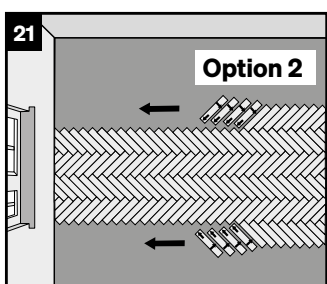
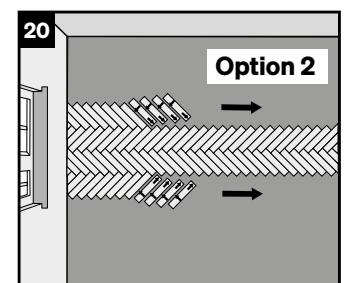
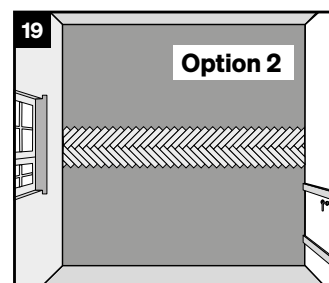
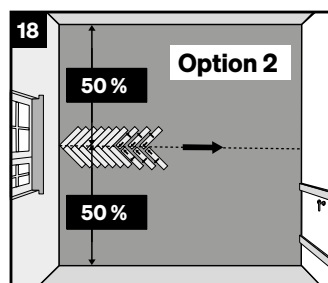
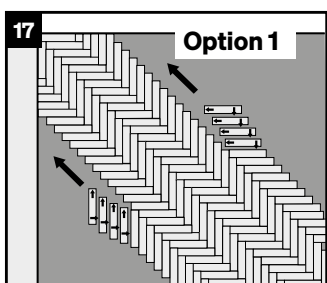
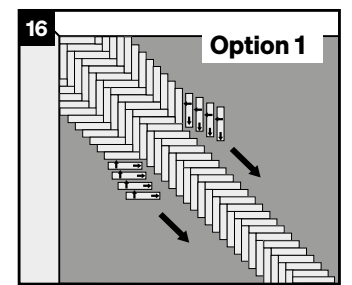
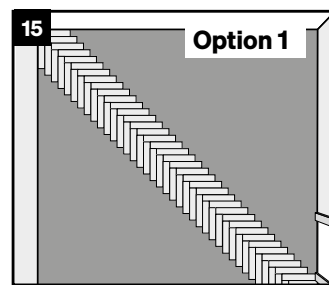
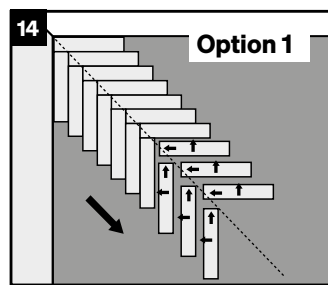
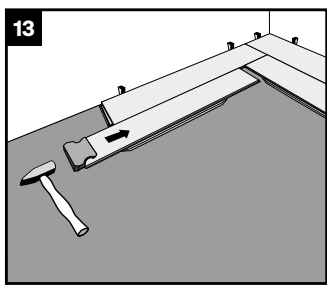
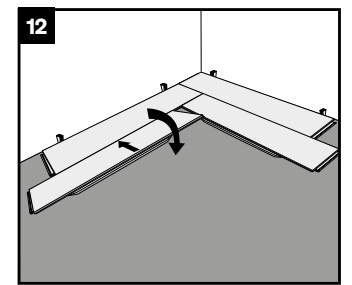
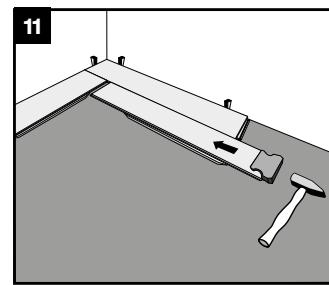
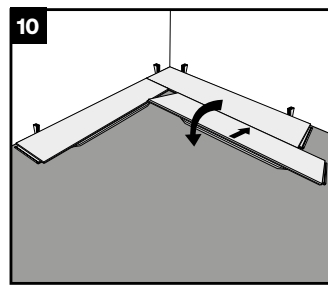
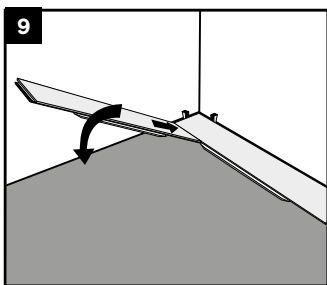
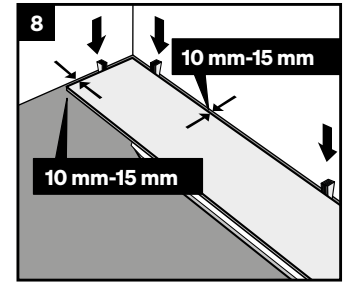
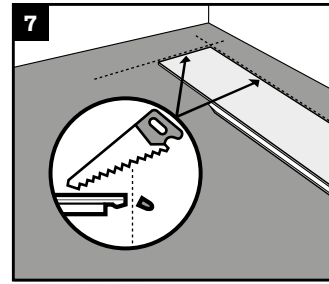
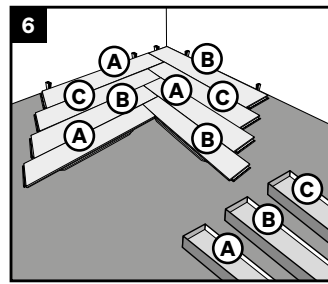
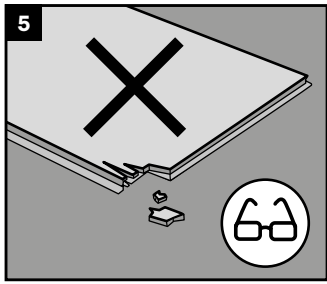
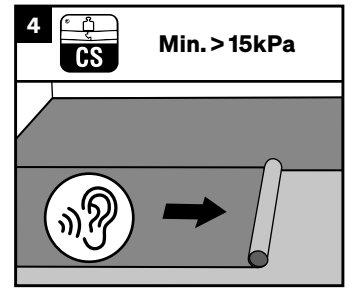
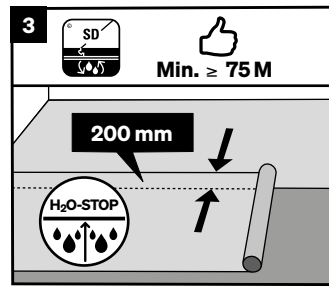
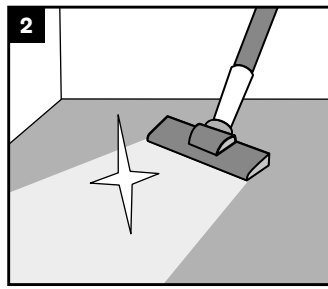
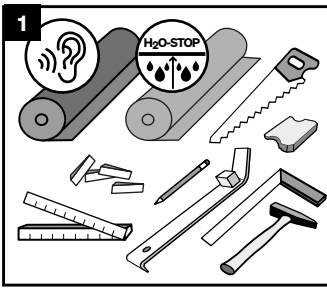

Parquet flooring and wood flooring Natureflex with Multiclic technology



Fig. 1

The following tools and aids are required to install MeisterParquet. longlife and wood flooring Natureflex with Multiclic technology:

Hammer, keyhole or electric saw, possibly power drill, folding metre rule, pencil, wedges (spacer wedges), heel bar, angle or adjustable bevel, MEISTER tapping block, possibly moisture protection film (SD value ≥ 75 m).

If you are using products without sound-absorbing Silence cushioning, use the system-specific MEISTER insulating underlay. Any other insulating underlay must have a suitable pressure stability (CS value ≥ 15 kPa).

The flooring is installed floating without glue. The specially designed click connection allows quick and easy installation. Two different installation options are available to choose from. Option 1: Angle in the short and long side; Option 2: Angle in the long side and join the short end using the MEISTER tapping block and several light taps with the hammer.

Fig. 2

Remove any dirt, small stones, etc. from the surface prior to installation.

Fig. 3

A moisture protection film must be laid out to form a 'bath' on all mineral subfloors (except poured asphalt screed) as a moisture-resistant barrier. The strip edges must overlap by at least 20 cm and the overlapping edges must be masked off. Alternatively, the option is available to use MEISTER insulating underlay with an integrated moisture-resistant barrier.

Fig. 4

Lay the corresponding MEISTER insulating underlay with a pressure resistance of >15 kPa.

Fig. 5

Before installation, check all planks in daylight for recognisable faults in colour and structure. No claims can be made for goods that have already been installed.

Fig. 6

Install a mixture of planks from different packages.

Fig. 7

When sawing the elements, make sure you work from the correct side: if you use a bench saw, keep the decorative side facing up, if you use a keyhole or portable circular saw, keep the decorative side down.

Start by laying the first complete plank in the left-hand corner of the room with the tongue sides facing the wall. Saw the tongues off the first plank, both on the short and the long side. Remove only the tongues on the long sides of all the other planks you want to lay in the first row.

Fig. 8

Using wedges, you can easily keep a gap of at least 10-15 mm from the wall.

Fig. 9

Angle the short end of the next complete plank into plank 1. Install the other planks in this row in exactly the same way across the entire width of the room.

Fig. 10 + Fig. 14

The last planks in each row are cut to size so that a gap of at least 10-15 mm to the wall is taken into account. You can use cut-off pieces of planks to start subsequent rows.

Option 1

Make sure that the planks in the first row are straight. Cut the first plank of the second row down to approx. 80 cm.

Fig. 11

Angle the short end of the next complete plank into the previous plank.

Fig. 12 + Fig. 13

Once you have angled in all of the planks in a row, angle them into the previously laid row and press them down slowly using a forward and downward turning motion. The row of planks should click into the previously installed row. Alternatively, you can angle in the short end of each individual plank first and then connect the long side by slightly raising it and angling it into the previous row. Continue the installation row by row in this way.

Option 2

Fig. 15

Cut the first plank of the second row down to approx. 80 cm. Angle this plank with the tongue into the groove side of the previous row of planks and press the plank down slowly using a forward and downward turning motion. The plank should click into the previously installed row.

Again, angle the next complete plank in the second row first on its long side against the previously laid row. Make sure the long joint is always tight.

Fig. 16

Once you have angled in the plank so it lies flat on the subfloor, click the head ends together using the MEISTER tapping block and light taps with the hammer. Continue the installation row by row in this way.

Fig. 17

Remember that the short-end joints must always be offset by at least 30-40 cm.

Fig. 18 + Fig. 19

The last planks in each row are cut to size so that a gap of at least 10-15 mm to the wall is taken into account. Lay the plank with the tongue side facing the wall to mark the remaining plank width.

Fig. 20

Start by laying the last row in the right-hand corner of the room and angle the long side of the plank into the second-last row.

Fig. 21

The next plank is angled in along the long side and lowered down in the same way. The short-end connection is then established with the help of a heel bar and several light taps with the hammer.

Fig. 25

Next, remove the wooden wedges from around the walls.

Fig. 26

Screw the skirting board clips to the wall at intervals of 40-50 cm. To ensure that the skirting board fits tightly, do not position it on an uneven wall.

Fig. 27

The skirting board is placed on the clip from above and pressed down. For the length joints of the skirting boards, the clip is placed on the joint with a half overlap to ensure a good hold. Please avoid bringing any silicone products into contact with the skirting boards.

Fig. 22 - Fig. 24

To take a plank row back out again, lift the entire row, levering it at the side out of the last row. You can then separate the short ends of the planks by angling them. This way, the locking system remains intact and the planks can be refitted.

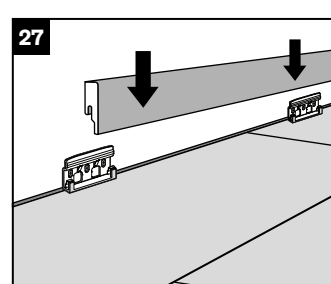
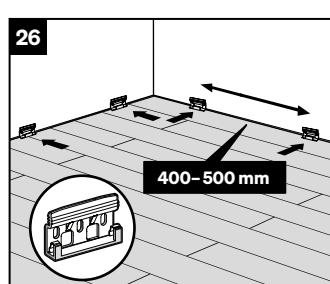
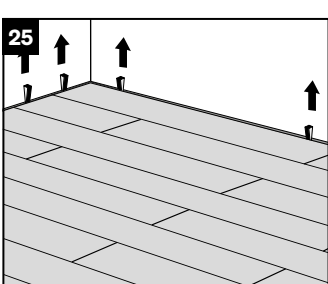
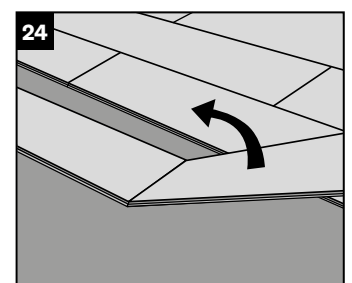
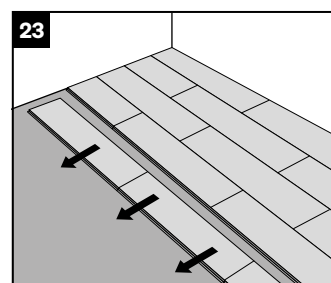
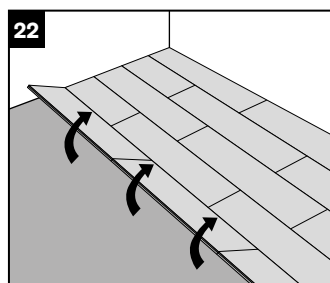
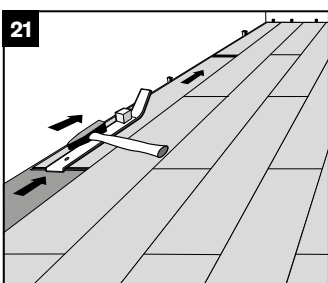
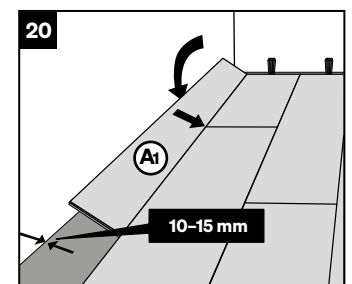
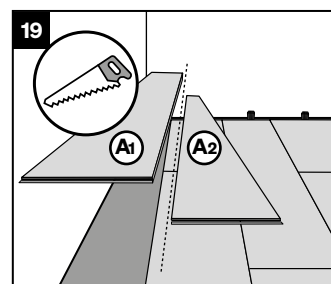
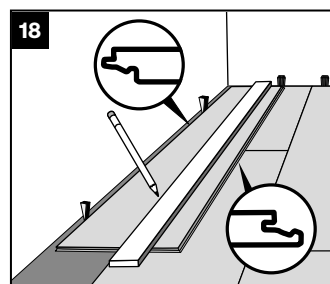
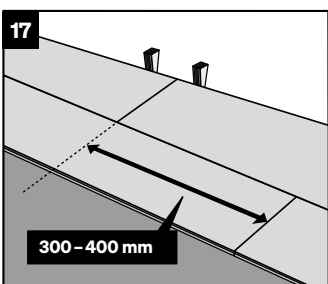
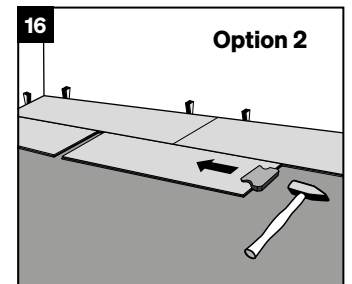
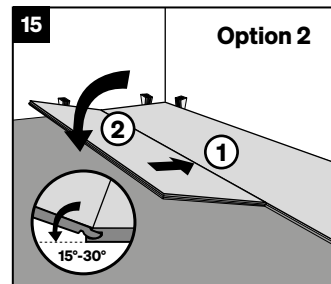
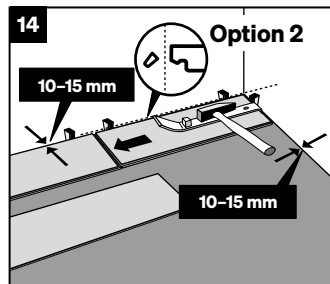
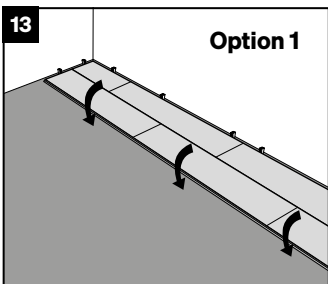
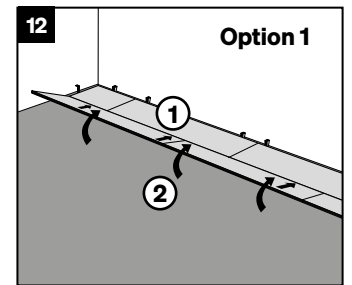
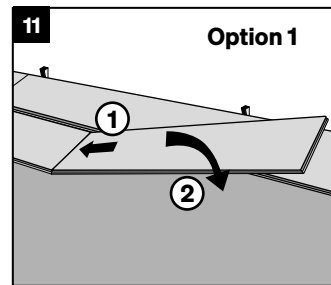
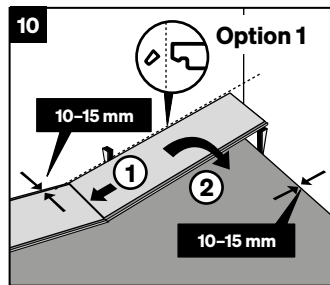
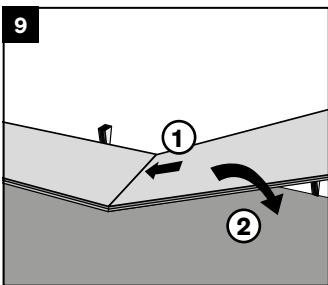
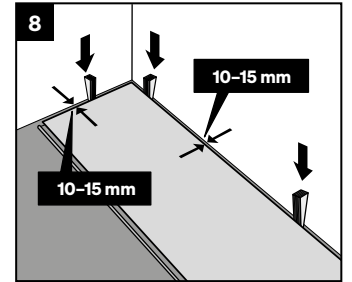
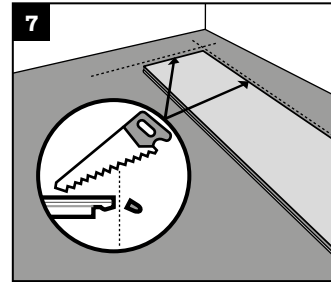
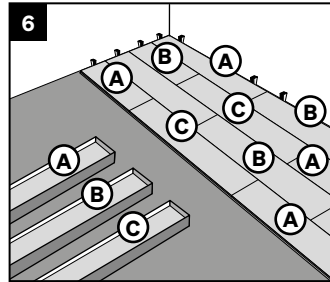
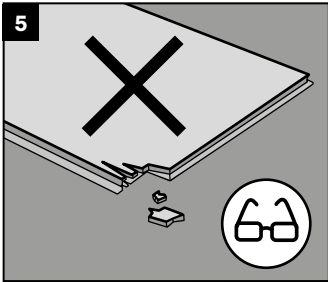
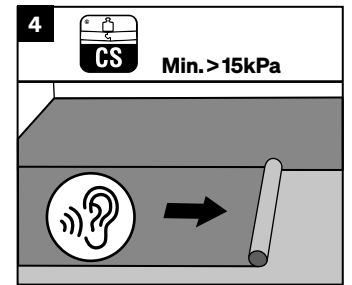
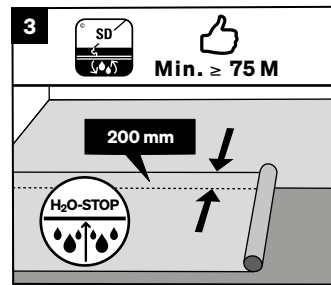
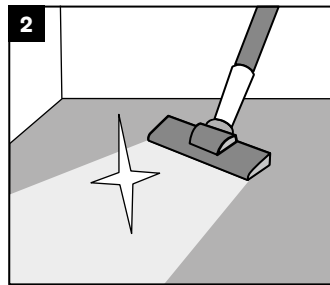
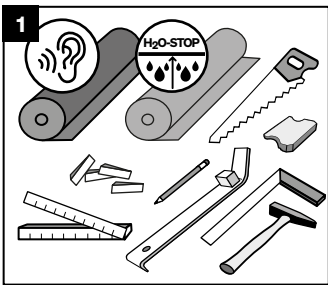

Installation instructions for fastening **MeisterParquet. longlife** PD 450, PD 400, PC 200 (TOP 13 clip) and **Lindura® wood flooring** HD 400 (TOP 11 clip) to the wall

Preparatory measures

Before opening the packages, leave them to acclimatise until they have adjusted to room temperature. Store them for approx. 48 hours (3-4 days in winter) flat on the floor in the centre of the room you want to work in. Do not store the packages in front of damp or freshly wallpapered walls. Before you install the planks, the conditions must comply with the general requirements for the installation of wooden materials in interior rooms. Make sure that the walls are dry, i.e. contain a maximum residual moisture of 5 per cent. All windows and doors must also have been installed and the room temperature must be around 20°C with approx. 30–65 per cent relative humidity.

During installation, make sure that air can also circulate behind the wood panelling (possibly provide batten backing structure). It is important to avoid trapped air. It is also important during installation that you allow a gap of at least 10–15 mm next to all walls and other fixed elements. If the floor area is longer or wider than 10 metres, you must provide an expansion joint.

Substructure with type 8 batten profile

Place the type 8 batten profile at maximum intervals of 40 cm (**Fig. 1**). Please use suitable plugs or screws to screw the substructure to the wall at intervals of 50 cm. Correct any slight unevenness in the wall by placing spacers or wooden wedges underneath. Use a standard metal hacksaw or one-hand angle grinder with metal cutting disc to trim the profile. A minimum gap of 20 mm is required when installing recessed lights. This must be guaranteed by fixing the batten profile to the wall using a spacer of at least 12 mm.

Installation

With the Masterclic Plus system, the planks are installed from right to left (**Fig. 9**). Start by laying the first complete plank with the tongue side facing the floor. With all the planks in the first row, remove the tongues along the long sides.

To install the first row, use the start/end clip. Mark the profile position on the back of the plank to fix these in place. The middle of the rail is marked using a pencil (**Fig. 2**) and the start/end clip is fixed using the supplied screws (**Fig. 3**). Tighten the screws but do not over tighten them. Then simply clip the plank into the batten profile (**Fig. 4**). If the clip does not slot in correctly, then the profile may have been pressed together during trimming. In this case, please bend open the profile to its original dimensions again.

Use the TOP 13/TOP 11 clip to fix the planks for the rest of the installation. To do this, simply screw the clip onto the batten profile (**Fig. 5**) and push it onto the plank groove (**Fig. 6 + 7**). Make sure that the planks in the first row are straight.

Angle the tongue of the first plank in the second row into the groove of the previous row of planks (**Fig. 8**) and slowly press the planks onto the batten profile. Use the TOP 13/TOP 11 clip to fix the planks for the rest of the installation (**Fig. 7**). Continue installing the planks row by row in this way (**Fig. 10**).

To cut the last row to size, use a spare piece of plank and draw the remaining plank width on it (leaving a gap of 10–15 mm to the ceiling).

Taking the plank marked for width, push the plastic tongue on the short end forward out of the end groove using the spare piece of plank (**Fig. 11**). Begin cutting the plank to size at the short end of the plastic tongue. Once the plank has been cut to size, push the plastic tongue at the short end back into the end groove (**Fig. 12 + 13**).

To install the start/end clips on the last row, mark the position of the batten profile using a piece of adhesive tape (**Fig. 14**) and transfer the position of the profile onto the back of the plank (**Fig. 15 + 16**). The clip can now be fixed onto the plank in the first row (**Fig. 17**) and inserted into the plank (**Fig. 18**). The plastic tongue in the last row then has to be fixed in place using a screwdriver (**Fig. 19**).

Use a trim such as the MEISTER angled cover moulding to cover the all-round expansion joints (**Fig. 20 + 22**).



Fig. 1



Fig. 2



Fig. 3



Fig. 4



Fig. 5



Fig. 6

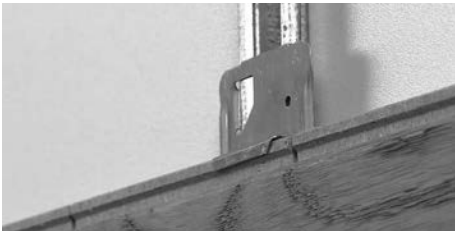

Fig. 7



Fig. 8



Fig. 9



Fig. 10



Fig. 11

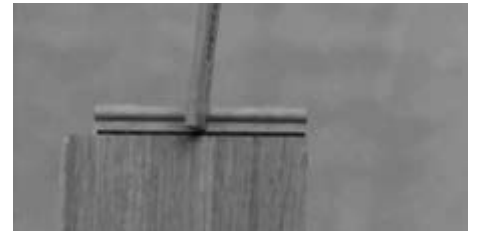

Fig. 12



Fig. 13



Fig. 14



Fig. 15



Fig. 16



Fig. 17



Fig. 18

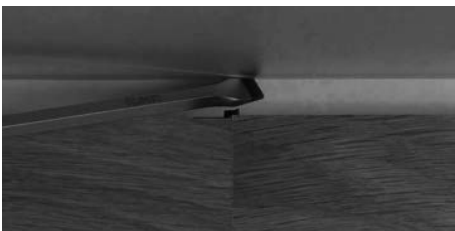

Fig. 19



Fig. 20



Fig. 21



Fig. 22

Design flooring with Masterclik Plus technology



Fig. A1 + A2

The flooring is installed floating without glue. The Masterclik Plus connection system makes it possible to install the flooring quickly and easily. The short-end interlocking occurs when the next row is laid. This also makes for a valuable installation aid, as the planks can be aligned against each other in this way. To do this, you should lift the plank slightly and simply square it with the tongue in the groove of the plank that has already been laid.

Fig. 1

The following tools and aids are required to install MEISTER design flooring with Masterclik Plus technology:

Hammer, keyhole or electric saw, possibly power drill, folding metre rule, pencil, wedges (spacer wedges), heel bar, angle or adjustable bevel, possibly moisture protection (SD value ≥ 75 m). If you are using products without sound-absorbing Silence cushioning, use the system-specific MEISTER insulating underlay. Any other insulating underlay must have a suitable pressure stability (CS value ≥ 15 kPa).

Fig. 2

Remove any dirt, small stones, etc. from the surface prior to installation.

Fig. 3

A moisture protection film must be laid out to form a 'bath' on all mineral subfloors (except poured asphalt screed) as a moisture-resistant barrier. The strip edges must overlap by at least 20 cm and the overlapping edges must be masked off. Alternatively, the option is available to use MEISTER insulating underlay with an integrated moisture-resistant barrier.

Fig. 4

Lay the corresponding MEISTER insulating underlay with a pressure resistance of >15 kPa in the private residential sector or >60 kPa in the commercial sector.

Fig. 5

Before installation, check all planks in daylight for recognisable faults in colour and structure. No claims can be made for goods that have already been installed.

Fig. 6

Install a mixture of planks from different packages.

Fig. 7

When sawing the elements, make sure you work from the correct side: if you use a bench saw, keep the decorative side facing up, if you use a keyhole or portable circular saw, keep the decorative side down. Start by laying the first complete plank in the left-hand corner of the room with the tongue sides facing the wall. Remove only the tongues on the long sides of all the other planks you want to lay in the first row. Using wedges, you can easily keep a gap of at least 10 mm from the wall.

Fig. 8

Insert the head end of the next complete plank into plank 1. Install the other planks in this row in exactly the same way across the entire width of the room.

Fig. 9

The last planks in each row are cut to size so that a gap of at least 10 mm to the wall is taken into account. You can use cut-off pieces of planks to start subsequent rows.

Fig. 10

Make sure that the planks in the first row are straight. Cut the first plank of the second row down to approx. 80 cm (for MeisterDesign. next DB 500 S and MeisterDesign. comfort DB 600 S, 50–60 cm).

Angle this plank flat with the tongue as far as possible into the groove side of the previous row of planks and press the plank down slowly using a forward and downward turning motion. The plank should click into the previously installed row.

Fig. 11

Similarly, the next complete plank is turned into the click connection on the long side and the head end pushed tight against the previous plank before it is lowered. Then press the plank down slowly using a forward and downward turning motion. The plank has to click into the previously installed row and the short-end joint with the previous plank has to be closed.

Fig. 12

Continue the installation row by row in this way. Remember that the end joints must always be offset by at least 30–40 cm (for MeisterDesign. next DB 500 S and MeisterDesign. comfort DB 600 S, 25 cm).

Fig. 13 + Fig. 14

The last planks in each row are cut to size so that a gap of approx. 10 mm to the wall is taken into account. Lay the plank with the tongue side facing the wall to mark the remaining plank width.

Fig. 15

Taking the plank marked for width, push the plastic tongue at the short end forward out of the end groove using the spare piece of plank.

Fig. 16

Begin cutting the plank to size at the short end of the plastic tongue.

Fig. 17

After the plank has been cut to size, push the plastic tongue at the short end back into the end groove. Start by laying the last row in the right-hand corner of the room (leaving at least a 10 mm gap to the wall) and angle the long side of the plank into the second-last row. The next plank is angled in the same way and lowered down at the short end.

Fig. 18

Push the plastic tongue that is pointing out towards the wall back into the short-end connection using a heel bar, scraper, screwdriver or similar.

Fig. 22

Next, remove the wooden wedges from around the walls.

Fig. 23

Screw the skirting board clips to the wall at intervals of 40–50 cm. To ensure that the skirting board fits tightly, do not position it on an uneven wall.

Fig. 24

The skirting board is placed on the clip from above and pressed down. For the length joints of the skirting boards, the clip is placed on the joint with a half overlap to ensure a good hold.

Please avoid bringing any silicone products into contact with the skirting boards.

Fig. 19 – Fig. 21

To take a plank row back out again, lift the entire row, levering it at the side out of the last row. You can then slide the planks apart at the short ends. Should you wish to reuse the disassembled planks, you should first push the plastic tongue at the short end back into the top groove so it sits flush.

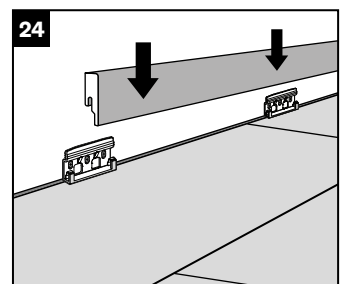
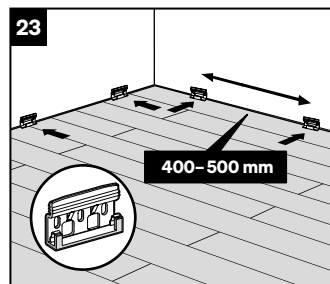
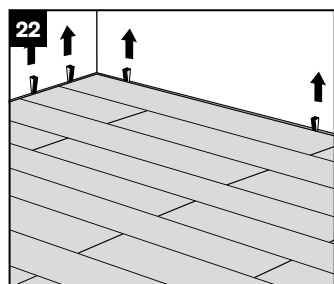
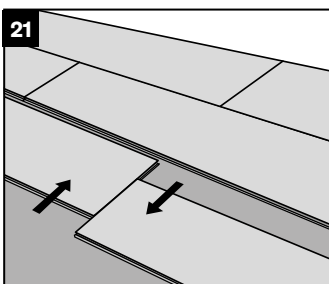
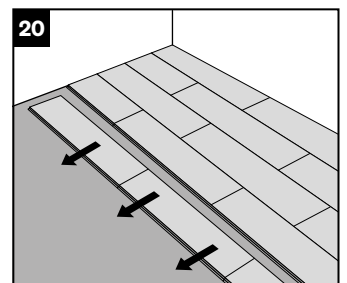
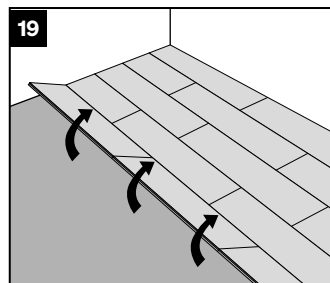
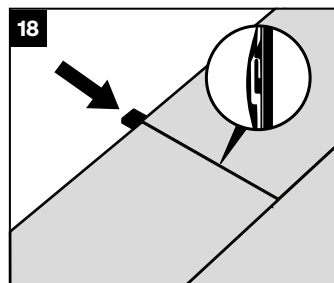
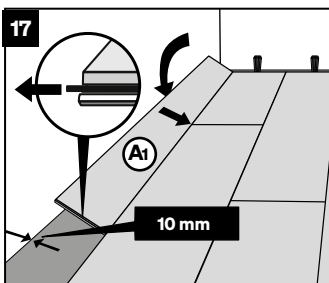
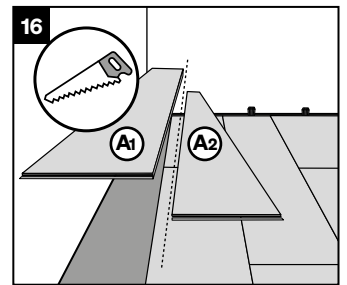
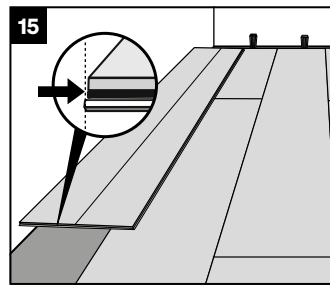
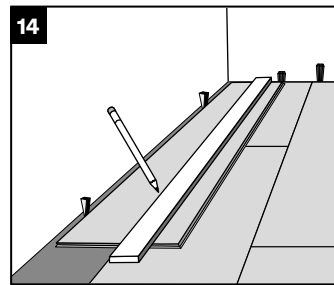
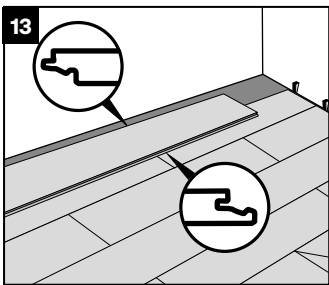
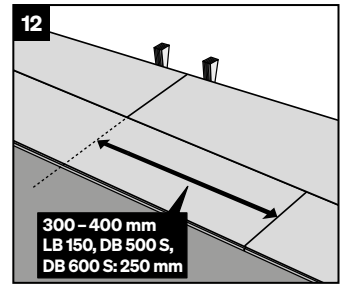
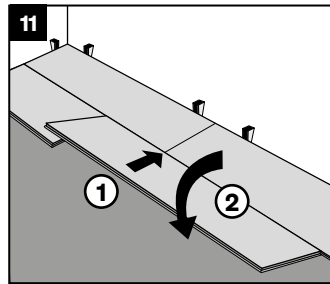
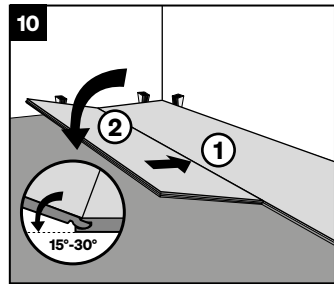
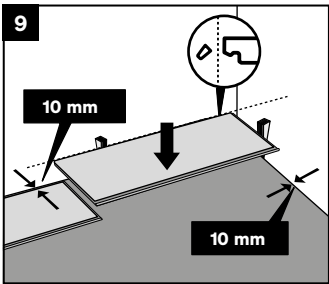
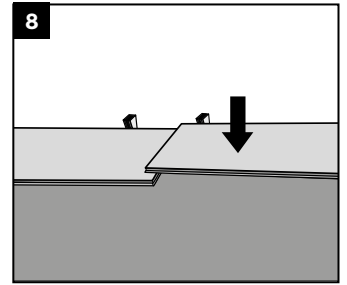
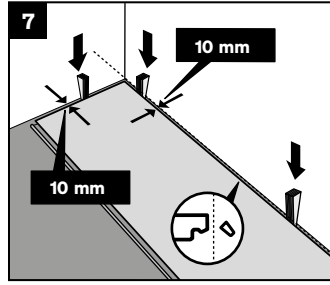
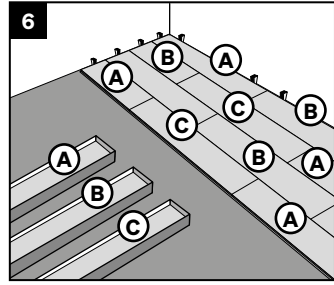
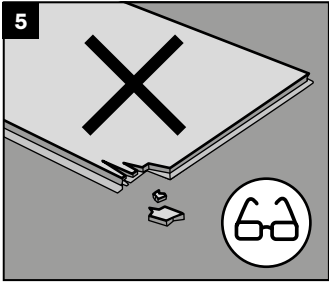
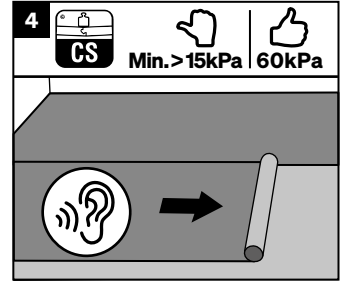
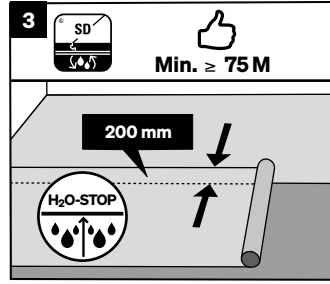
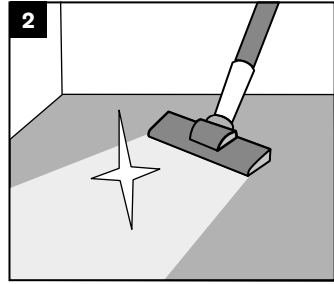
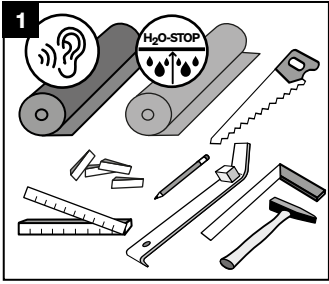
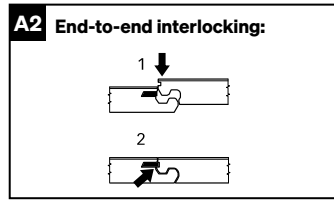
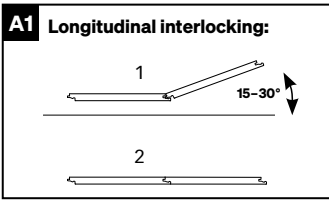

Laminate flooring with 5G™ Dry™ technology



Fig. A1 + A2

The flooring is installed as a floating structure without glue. The 5G™ Dry™ connection system makes it possible to install the flooring quickly and easily. In addition, it is a valuable installation aid, as the planks can be aligned against each other in this way. To do this, you should lift the plank slightly and simply square it with the tongue in the groove of the plank that has already been laid.

Fig. 1

You need the following tools and aids to install laminate flooring MeisterDesign. laminate with 5G™ Dry™ technology:

Hammer, keyhole or electric saw, possibly power drill, folding metre rule, pencil, wedges (spacer wedges), heel bar, angle or adjustable bevel, possibly moisture protection film (SD value ≥ 75 m). Furthermore, if you are using products without a sound-absorbing Silence cushion, use the system-bound MEISTER insulating underlay. Any other insulating underlay must have a suitable pressure stability (CS value ≥ 15 kPa).

Fig. 2

Remove any dirt, small stones, etc. from the surface prior to installation.

Fig. 3

A moisture protection film must be laid out to form a "bath" on all mineral substrates (except poured asphalt screed) as a vapour barrier. The strip edges must overlap by at least 20 cm and the overlapping edges must be masked off. Alternatively, the option is available to use MEISTER insulating underlay with integrated vapour barrier.

Fig. 4

Lay the corresponding MEISTER insulating underlay with a pressure resistance of > 15 kPa in the private residential sector or > 60 kPa in the commercial sector.

Fig. 5

Before installation, check all planks in daylight for recognisable faults in colour and structure. Goods already installed cannot be claimed for later.

Fig. 6

Install a mixture of planks from different packages.

Fig. 7

When sawing the elements, make sure you work from the correct side: if you use a bench saw, keep the decorative side facing up, if you use a keyhole or portable circular saw, keep the decorative side down.

Start by laying the first complete plank in the left-hand corner of the room with the tongue sides facing the wall. Remove only the tongues on the long sides of all the other planks you want to lay in the first row. Using wedges, you can easily keep a gap of at least 10 mm from the wall.

Fig. 8

Insert the head end of the next complete plank into plank 1. Install the other planks in this row in exactly the same way across the entire width of the room.

Fig. 9

The last planks in each row are cut to size so that a gap of 10 mm to the wall is taken into account. You can use cut-off pieces of planks to start subsequent rows.

Fig. 10

Make sure that the planks in the first row are straight. Cut the first plank of the second row down to approx. 80 cm.

Fix this plank with the tongue as far as possible into the groove on the long side of the previous row of planks and press the plank down slowly using a forward and downward turning motion. The plank has to click into the previously installed row.

Fig. 11

Similarly, the next complete plank is turned into the click connection on the long side and the head end pushed tight against the previous plank before it is lowered. Then press the plank down slowly using a forward and downward turning motion. The plank has to click into the previously installed row and the end joint with the previous plank has to be closed.

Fig. 12

Press the short-end edge down so that it clicks into place audibly.

Fig. 13

Continue installing the panels row by row in this way. Remember that the end joints must always be offset by at least 30–40 cm.

Fig. 14 + Fig. 16

Cut the last plank in each row so that you leave a gap of approx. 10 mm to the wall. Lay the plank with the tongue side facing the wall to mark the remaining plank width.

Fig. 17

Start by laying the last row in the right-hand corner of the room (leaving at least a 10 mm gap to the wall) and angle the long side of the plank into the second-last row. The next plank is angled in the same way and lowered down at the end.

Fig. 18

Press the short-end edge down so that it clicks into place audibly.

Fig. 22

Next, remove the wooden wedges from around the walls.

Fig. 23

Screw the skirting board clips to the wall at intervals of 40–50 cm. To ensure that the skirting board fits tightly, do not position it on an uneven wall.

Fig. 24

The skirting board is placed on the clip from above and pressed down. For the length joints of the skirting boards, the clip is placed on the joint with a half overlap to ensure a good hold. Please avoid bringing any silicone products into contact with the skirting boards.

Fig. 19 – Fig. 21

To take a plank row back out again, lift the entire row, levering it at the side out of the last row. You can then slide the planks apart at the ends.

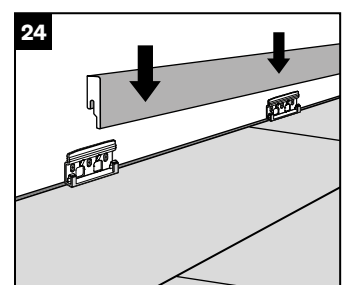
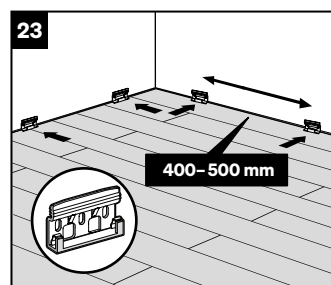
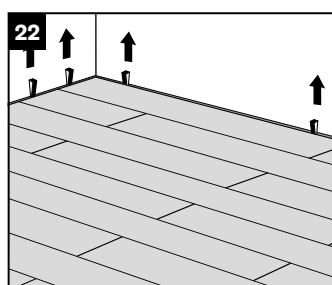
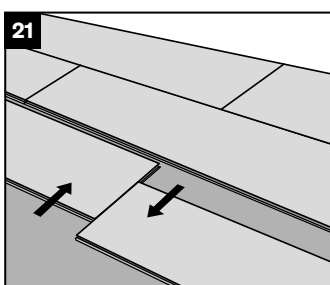
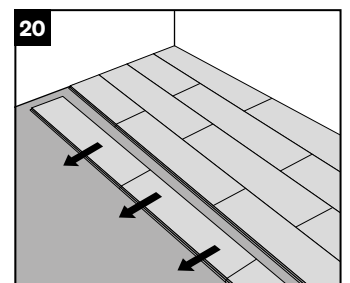
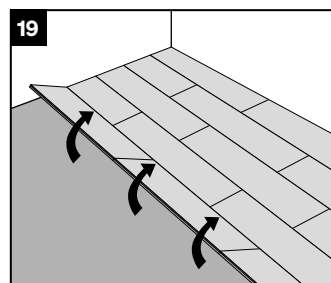
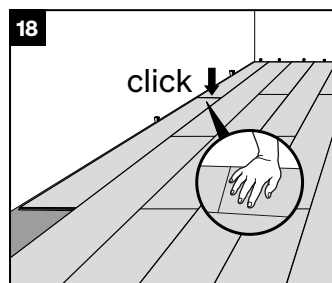
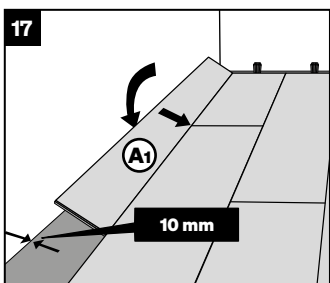
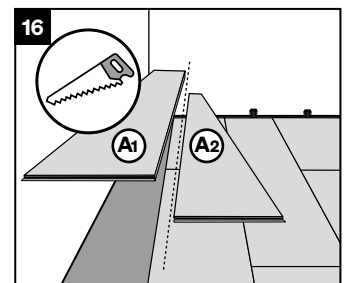
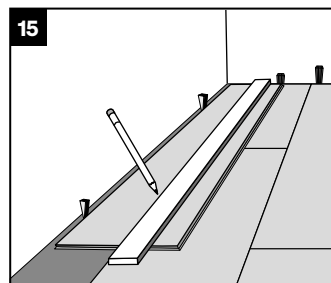
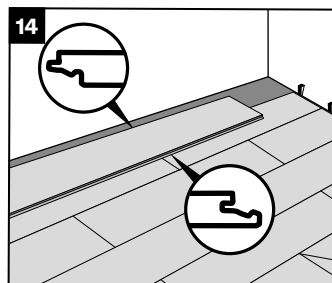
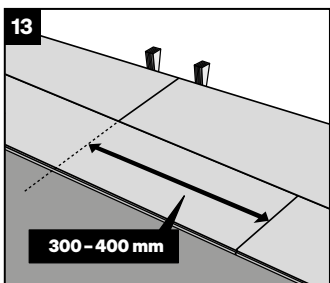
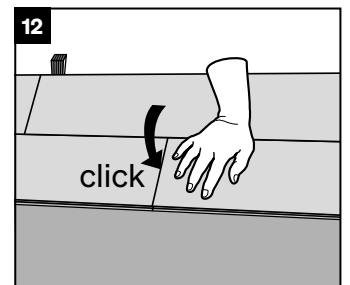
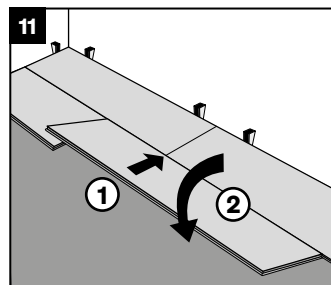
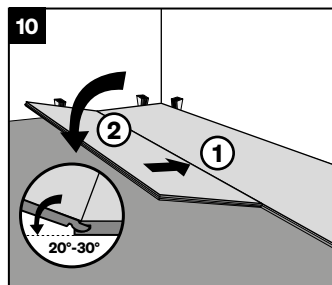
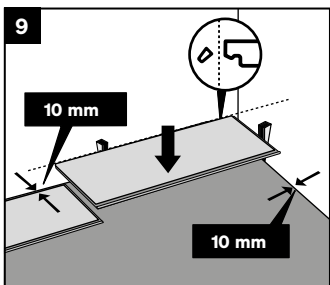
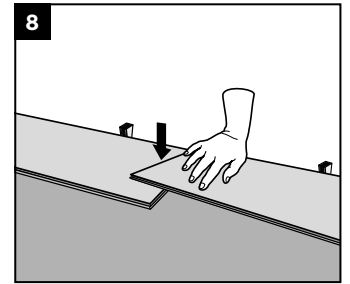
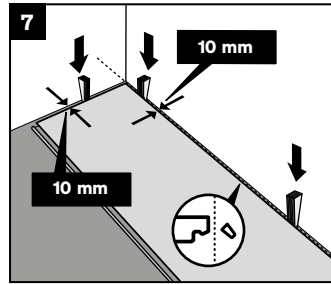
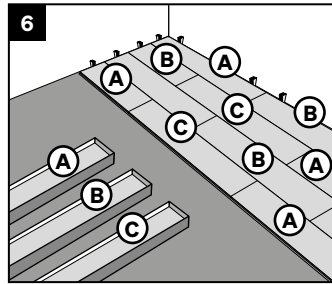
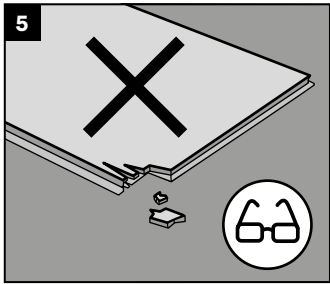
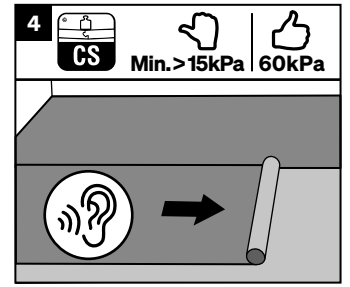
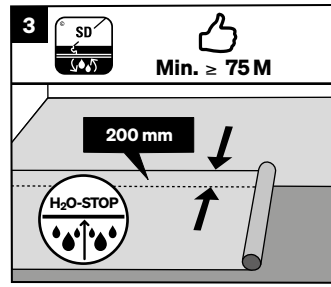
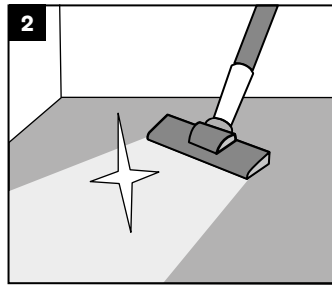
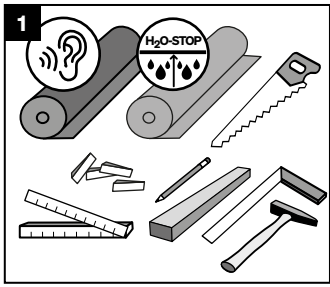
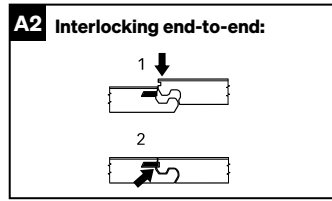
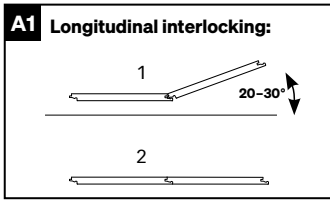

Laminate flooring with UniZip-technology

Fig. 1

You need the following tools and aids to install MeisterDesign. laminate flooring with UniZip technology:
hammer, keyhole or electric saw, possibly power drill, folding metre rule, pencil, MEISTER tapping block, wedges (spacer wedges), heel bar, angle or adjustable bevel, possibly moisture protection film (SD value ≥ 75 m).
Furthermore, if you are using products without a sound-absorbing Silence cushion, use the system-bound MEISTER insulating underlay. Any other insulating underlay must have a suitable pressure stability (CS value ≥ 60 kPa).

Fig. 2

Remove any dirt, small stones, etc. from the surface prior to installation.

Fig. 3

A moisture protection film must be laid out to form a "bath" on all mineral substrates (except poured asphalt screed) as a vapour barrier. The strip edges must overlap by at least 20 cm and the overlapping edges must be masked off. Alternatively, the option is available to use MEISTER insulating underlay with integrated vapour barrier.

Fig. 4

Lay the corresponding MEISTER insulating underlay with a pressure resistance of > 60 kPa.

Fig. 5

Before installation, check all planks in daylight for recognisable faults in colour and structure. Goods already installed cannot be claimed for later.

Fig. 6

Install a mixture of planks from different packages.

Diagonal herringbone pattern (option 1)

Fig. 14

In order to obtain a uniform distance to all walls, draw a guide line using a chalk line.

Fig. 7

Start the laying process in a corner of the room. Saw the tongues off the first plank, both on the short and the long side.

Fig. 8

Using wedges, you can easily keep a gap of 10 mm from the wall. On the second plank, only the tongue on the long side has to be cut off.

Fig. 9

Now angle the head end of the second plank into the long side of the first plank.

Fig. 10 + Fig. 11

Then angle the long side of the third plank into the first plank. Now interlock the short side of the third plank into the second plank using the MEISTER tapping block.

Fig. 12 – Fig. 14

Follow this process to continue laying. Make sure that the long sides of the planks are angled in first before interlocking the planks on their short sides.

Fig. 15

Lay the first braid as far as the wall/corner of the room. The left over pieces of planks there can possibly be used at the start of the next row. The first braid has to be fixed with wedges so that the braid does not slide during the subsequent laying process.

Fig. 16 + Fig. 17

Before starting with the next row, check if there are any leftover pieces that could be used. While continuing with the laying, ensure that the long sides of the planks are angled in first and only then interlock the head ends.

In certain situations, it is not possible to angle in the long side first before interlocking the head end. The special connection technique allows the plank to be interlocked in any conceivable direction, meaning the head end can be angled in first and the element can be interlocked via the long side, for example.

Following this sequence, lay the surface up to the end of the room. The planks that end at the wall are cut to size so that a gap of 10 mm to the wall is taken into account.

Parallel herringbone pattern (option 2)

Fig. 18

Draw a guide line using chalk to ensure a uniform distance to opposite walls. Start the installation in the middle of the room facing a wall. To ensure the installation is symmetrical, the installation line must be shifted by $\frac{1}{4}$ of the mitre width from the centre of the room.

Fig. 9

Angle the head end of the second plank into the long side of the first plank.

Fig. 10 + Fig. 11

Then angle the long side of the third plank into the first plank. Now interlock the short end of the third plank into the second plank using the MEISTER tapping block.

Fig. 18

Follow this process to continue the installation as far as the sixth plank. Align the planks with the installation line and cut them parallel to the wall. You can now align the short, head end (in the shape of a triangle) at an even distance of 10 mm from the wall along the installation line and fix it in place with wedges. Make sure that the long sides of the planks are angled in first before interlocking the short ends.

Fig. 19

Lay the first zigzag as far as the opposite wall. The leftover pieces of planks there can possibly be used at the start of the next row. The first zigzag has to be fixed with wedges so that the braid does not slide during the rest of the installation.

Fig. 20 + Fig. 21

Before starting the next row, check if there are any leftover pieces that could be used. Over the course of the installation, make sure that the long sides of the planks are angled in first before interlocking the head ends.

In certain situations, it is not possible to angle in the long side first before interlocking the head end. The special connection technique allows the plank to be interlocked in any conceivable direction, meaning the head end can be angled in first and the element can be interlocked via the long side, for example.

Install the entire area up to the end of the room in this sequence. The planks that end at the wall are cut to size so that a gap of 10 mm to the wall is taken into account.

Fig. 22

Next, remove the wooden wedges from around the walls.

Fig. 23

Screw the skirting board clips to the wall at intervals of 40–50 cm. To ensure that the skirting board fits tightly, do not position it on an uneven wall.

Fig. 24

The skirting board is placed on the clip from above and pressed down. For the length joints of the skirting boards, the clip is placed on the joint with a half overlap to ensure a good hold. Please avoid bringing any silicone products into contact with the skirting boards.

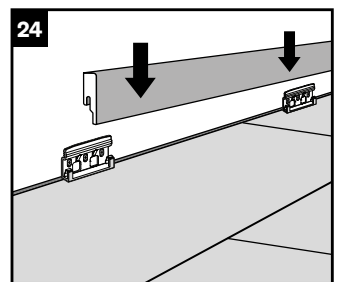
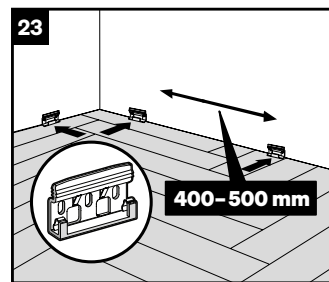
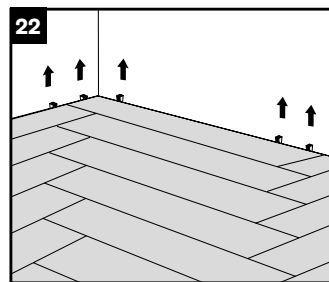
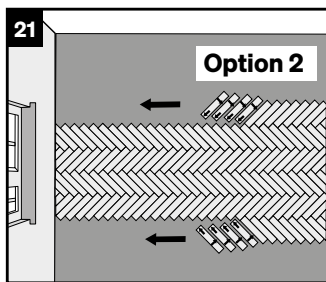
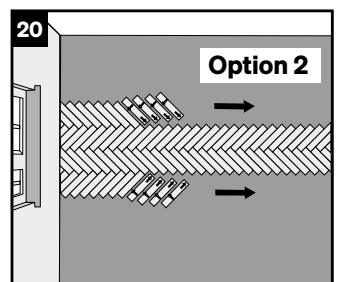
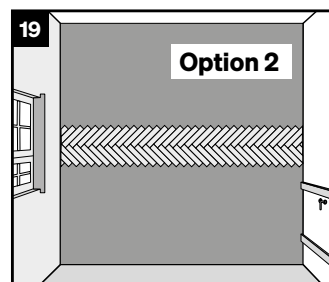
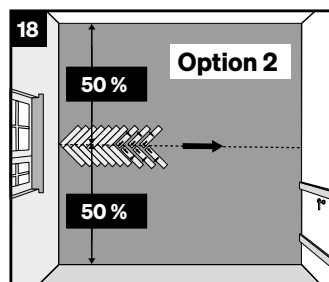
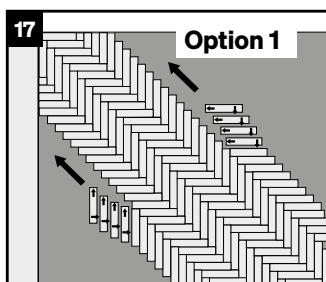
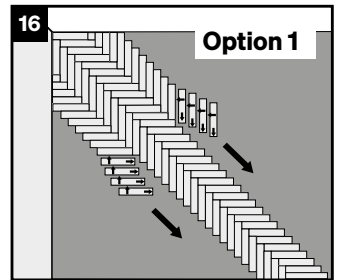
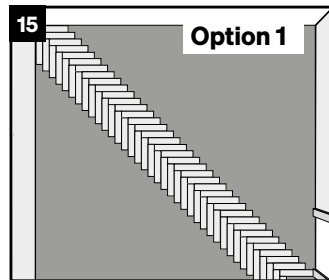
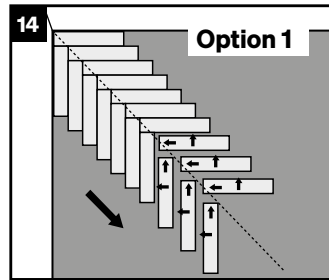
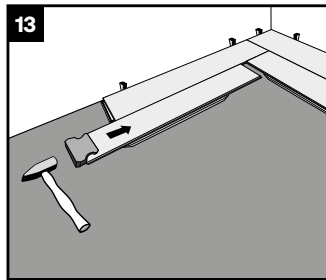
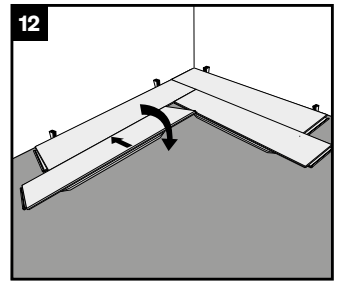
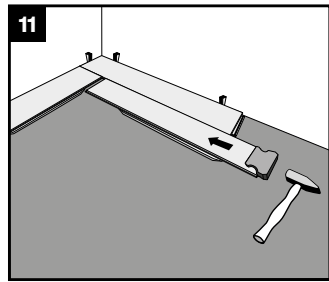
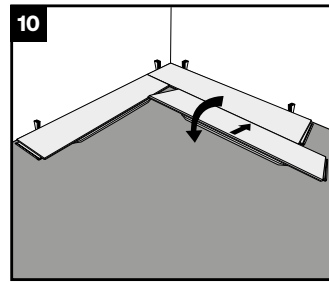
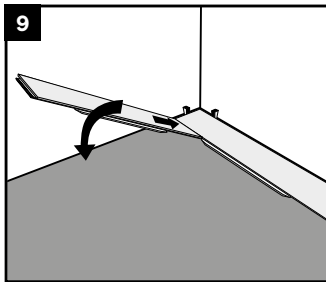
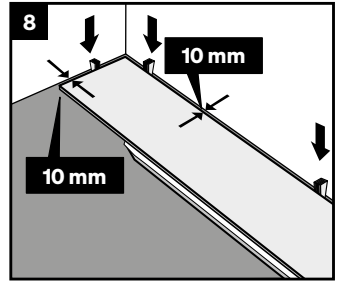
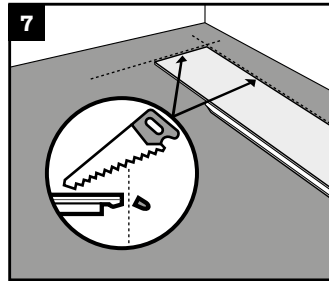
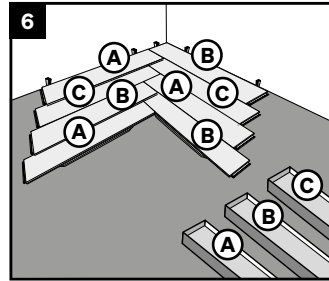
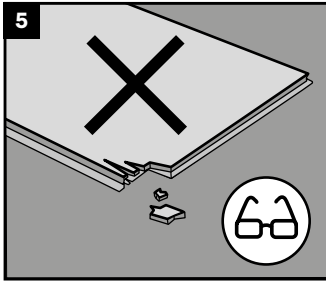
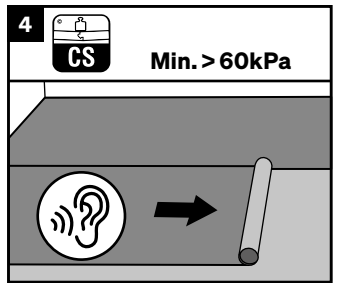
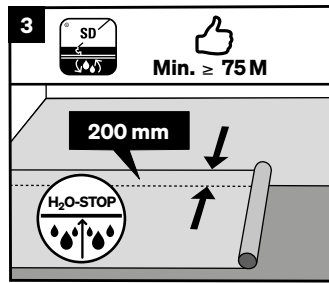
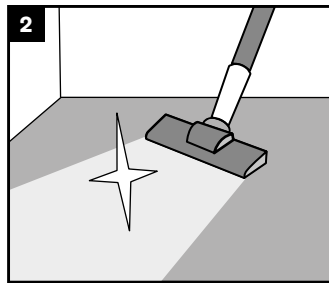
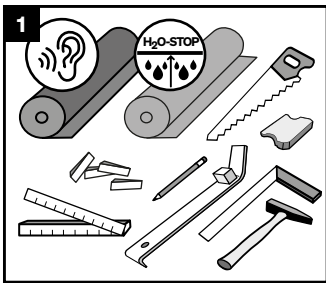

Laminate flooring with Multiclic technology



Fig. 1

The following tools and aids are required to install MEISTER laminate flooring with Multiclic technology.

Hammer, keyhole or electric saw, possibly power drill, folding metre rule, pencil, wedges (spacer wedges), heel bar, angle or adjustable bevel, MEISTER tapping block, possibly moisture protection film (SD value ≥ 75 m). If you are using products without sound-absorbing Silence cushioning, use the system-specific MEISTER insulating underlay. Any other insulating underlay must have a suitable pressure stability (CS value ≥ 15 kPa).

The flooring is installed floating without glue. The specially designed click connection allows quick and easy installation. Two different installation options are available to choose from. Option 1: Angle in the short and long side; Option 2: Angle in the long side and join the short end using the MEISTER tapping block and several light taps with the hammer.

Fig. 2

Remove any dirt, small stones, etc. from the surface prior to installation.

Fig. 3

A moisture protection film must be laid out to form a 'bath' on all mineral subfloors (except poured asphalt screed) as a moisture-resistant barrier. The strip edges must overlap by at least 20 cm and the overlapping edges must be masked off. Alternatively, the option is available to use MEISTER insulating underlay with an integrated moisture-resistant barrier.

Fig. 4

Lay the corresponding MEISTER insulating underlay with a pressure resistance of >15 kPa in the private residential sector or >60 kPa in the commercial sector.

Fig. 5

Before installation, check all planks in daylight for recognisable faults in colour and structure. No claims can be made for goods that have already been installed.

Fig. 6

Install a mixture of planks from different packages.

Fig. 7

When sawing the elements, make sure you work from the correct side: if you use a bench saw, keep the decorative side facing up, if you use a keyhole or portable circular saw, keep the decorative side down.

Start by laying the first complete plank in the left-hand corner of the room with the tongue sides facing the wall. Saw the tongues off the first plank, both on the short and the long side. Remove only the tongues on the long sides of all the other planks you want to lay in the first row.

Fig. 8

Using wedges, you can easily keep a gap of at least 10 mm from the wall.

Fig. 9

Angle the short end of the next complete plank into plank 1. Install the other planks in this row in exactly the same way across the entire width of the room.

Fig. 10 + Fig. 14

The last planks in each row are cut to size so that a gap of at least 10 mm to the wall is taken into account. You can use cut-off pieces of planks to start subsequent rows.

Option 1

Make sure that the planks in the first row are straight. Cut the first plank of the second row down to approx. 80 cm (LB 150: 50-60 cm).

Fig. 11

Angle the short end of the next complete plank into the previous plank.

Fig. 12 + Fig. 13

Once you have angled in all of the planks in a row, angle them into the previously laid row and press them down slowly using a forward and downward turning motion. The row of planks should click into the previously installed row. Alternatively, you can angle in the short end of each individual plank first and then connect the long side by slightly raising it and angling it into the previous row. Continue the installation row by row in this way.

Option 2

Fig. 15

Cut the first plank of the second row down to approx. 80 cm. Angle this plank with the tongue into the groove side of the previous row of planks and press the plank down slowly using a forward and downward turning motion. The plank should click into the previously installed row.

Again, angle the next complete plank of the second row first on its long edge against the previously laid row. Make sure the long joint is always tight.

Fig. 16

Once you have angled in the plank so it lies flat on the subfloor, click the head ends together using the MEISTER tapping block and light taps with the hammer. Continue the installation row by row in this way.

Fig. 17

Remember that the short-end joints must always be offset by at least 30–40 cm (LB 150: 25 cm).

Fig. 18 + Fig. 19

The last planks in each row are cut to size so that a gap of at least 10 mm to the wall is taken into account. Lay the plank with the tongue side facing the wall to mark the remaining plank width.

Fig. 20

Start by laying the last row in the right-hand corner of the room and angle the long side of the plank into the second-last row.

Fig. 21

The next plank is angled in along the long side and lowered down in the same way. The short-end connection is then established with the help of a heel bar and several light taps with the hammer.

Fig. 25

Next, remove the wooden wedges from around the walls.

Fig. 26

Screw the skirting board clips to the wall at intervals of 40–50 cm. To ensure that the skirting board fits tightly, do not position it on an uneven wall.

Fig. 27

The skirting board is placed on the clip from above and pressed down. For the length joints of the skirting boards, the clip is placed on the joint with a half overlap to ensure a good hold. Please avoid bringing any silicone products into contact with the skirting boards.

Fig. 22 – Fig. 24

To take a plank row back out again, lift the entire row, levering it at the side out of the last row. You can then separate the short ends of the planks by angling them. This way, the locking system remains intact and the planks can be refitted.

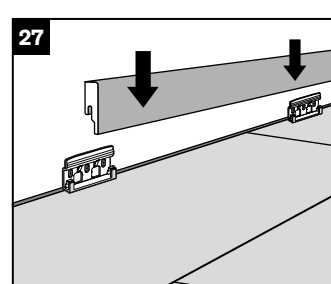
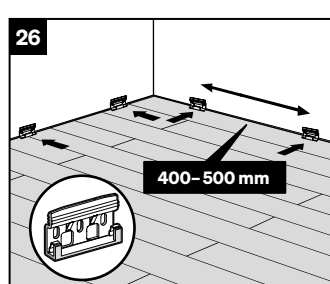
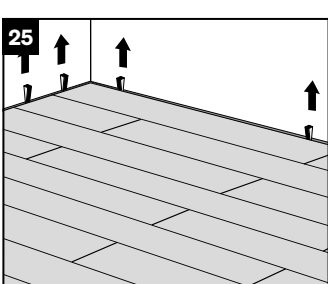
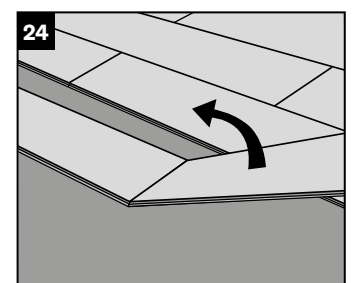
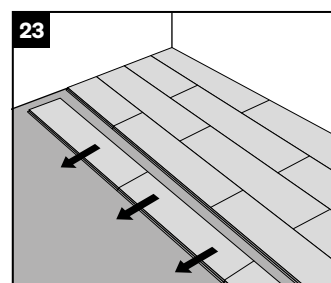
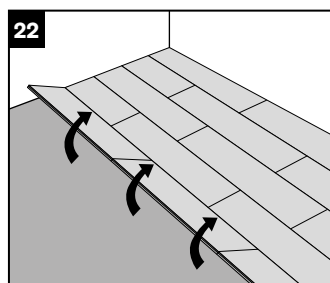
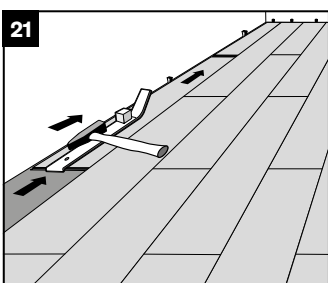
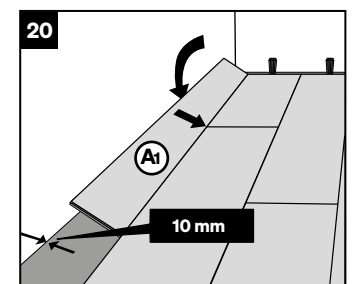
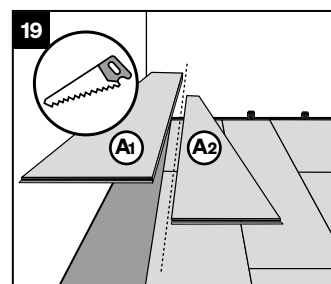
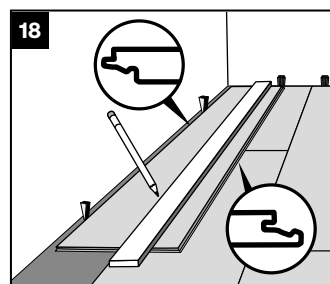
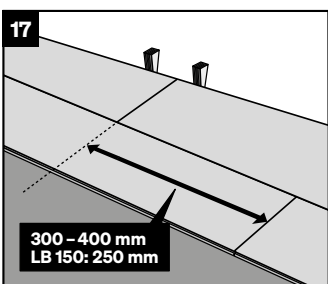
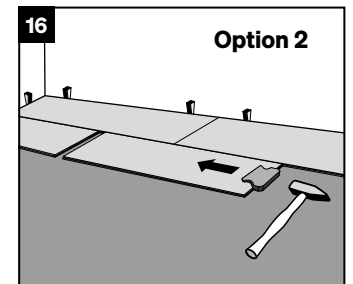
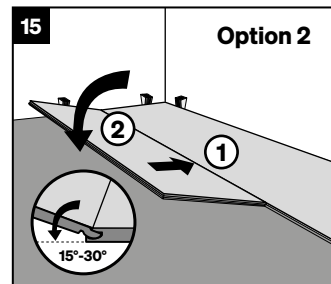
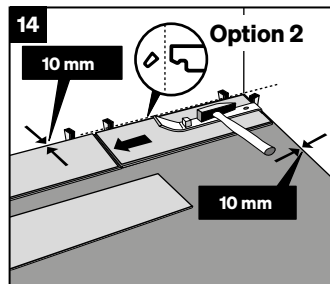
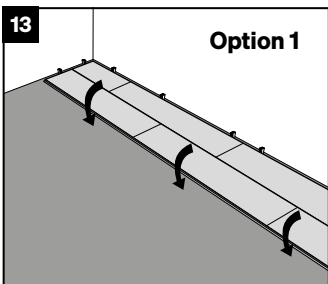
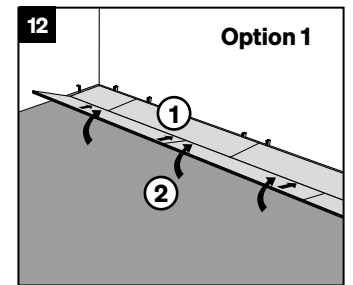
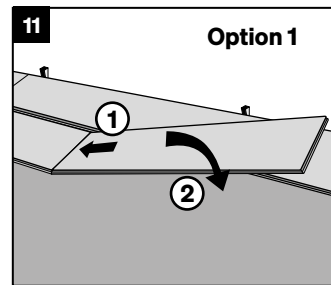
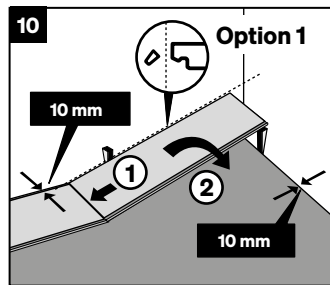
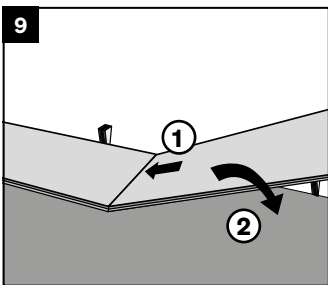
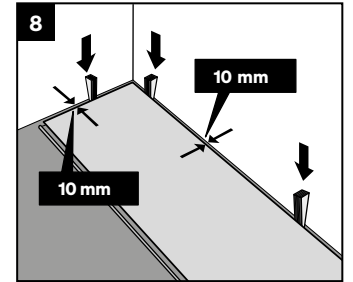
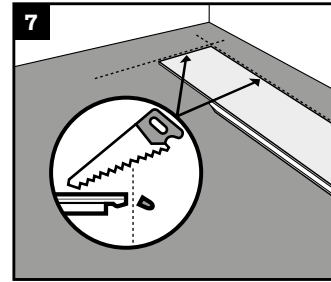
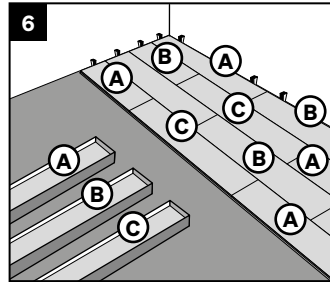
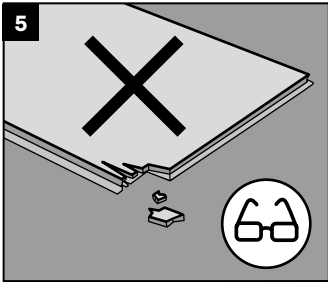
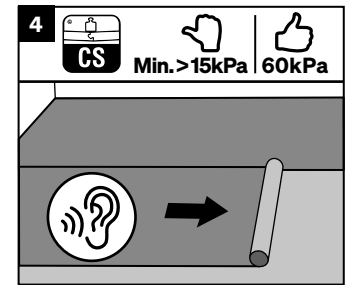
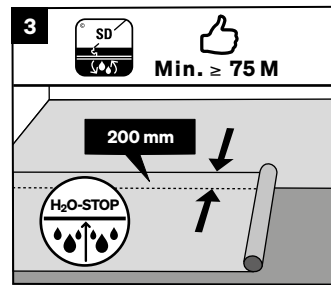
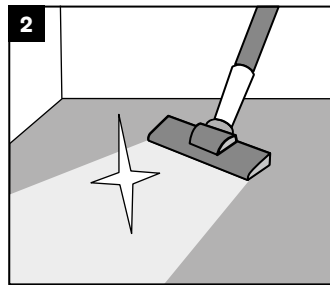
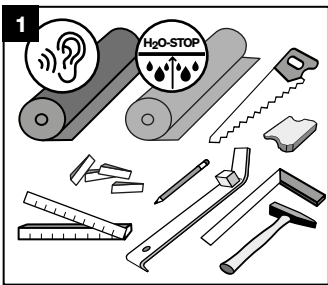

Design flooring MeisterDesign. flex with Multiclic technology



Fig. 1

The following tools and aids are required to install MEISTER design flooring with Multiclic technology:

Hammer, keyhole or electric saw, possibly power drill, folding metre rule, pencil, wedges (spacer wedges), heel bar, angle or adjustable bevel, MEISTER 5 mm tapping block, possibly moisture protection film (SD value ≥ 75 m). If you are using products without sound-absorbing Silence cushioning, use the system-specific MEISTER insulating underlay. Any other insulating underlay must have a suitable pressure stability (CS value ≥ 60 kPa).

The flooring is installed floating without glue. The specially designed click connection allows quick and easy installation. Two different installation options are available to choose from. Option 1: Angle in the head end and long side; Option 2: Angle in the long side and join the head end using the MEISTER 5 mm tapping block and several light taps with the hammer.

Fig. 2

Remove any dirt, small stones, etc. from the surface prior to installation.

Fig. 3

A moisture protection film must be laid out to form a 'bath' on all mineral subfloors (except poured asphalt screed) as a moisture-resistant barrier. The strip edges must overlap by at least 20 cm and the overlapping edges must be masked off. Alternatively, the option is available to use MEISTER insulating underlay with an integrated moisture-resistant barrier.

Fig. 4

Lay the corresponding MEISTER insulating underlay with a pressure resistance of >60 kPa.

Fig. 5

Before installation, check all planks in daylight for recognisable faults in colour and structure. No claims can be made for goods that have already been installed.

Fig. 6

Install a mixture of planks from different packages.

Fig. 7

When sawing the elements, make sure you work from the correct side: if you use a bench saw, keep the decorative side facing up, if you use a keyhole or portable circular saw, keep the decorative side down.

Start by laying the first complete plank in the left-hand corner of the room with the tongue sides facing the wall. Saw the tongues off the first plank, both on the short and the long side. Remove only the tongues on the long sides of all the other planks you want to lay in the first row.

Fig. 8

Using wedges, you can easily keep a gap of at least 10 mm from the wall.

Fig. 9

Angle the short end of the next complete plank into plank 1. Install the other planks in this row in exactly the same way across the entire width of the room.

Fig. 10 + Fig. 14

The last planks in each row are cut to size so that a gap of at least 10 mm to the wall is taken into account. You can use cut-off pieces of planks to start subsequent rows.

Option 1

Make sure that the planks in the first row are straight. Cut the first plank of the second row down to approx. 80 cm (or, for MeisterDesign. flex DB 400, 50–60 cm).

Fig. 11

Angle the short end of the next complete plank into the previous plank.

Fig. 12 + Fig. 13

Once you have angled in all of the planks in a row, angle them into the previously laid row and press them down slowly using a forward and downward turning motion. The row of planks should click into the previously installed row.

Alternatively, you can angle in the short end of each individual plank first and then connect the long side by slightly raising it and angling it into the previous row. Continue the installation row by row in this way.

Option 2

Fig. 15

Cut the first plank of the second row down to approx. 80 cm. Angle this plank with the tongue into the groove side of the previous row of planks and press the plank down slowly using a forward and downward turning motion. The plank should click into the previously installed row. Again, angle the next complete plank of the second row first on its long edge against the previously laid row. Make sure the long joint is always tight.

Fig. 16

Once you have angled in the plank so it lies flat on the subfloor, click the head ends together using the MEISTER 5 mm tapping block and light taps with the hammer. Continue the installation row by row in this way.

Fig. 17

Remember that the end joints must always be offset by at least 30–40 cm (or, for Meister Design. flex DB 400, 25 cm).

Fig. 18 + Fig. 19

The last planks in each row are cut to size so that a gap of at least 10 mm to the wall is taken into account. Lay the plank with the tongue side facing the wall to mark the remaining plank width.

Fig. 20

Start by laying the last row in the right-hand corner of the room and angle the long side of the plank into the second-last row.

Fig. 21

The next plank is angled in along the long side and lowered down in the same way. The short-end connection is then established with the help of a heel bar and several light taps with the hammer.

Fig. 25

Next, remove the wooden wedges from around the walls.

Fig. 26

Screw the skirting board clips to the wall at intervals of 40–50 cm. To ensure that the skirting board fits tightly, do not position it on an uneven wall.

Fig. 27

The skirting board is placed on the clip from above and pressed down. For the length joints of the skirting boards, the clip is placed on the joint with a half overlap to ensure a good hold. Please avoid bringing any silicone products into contact with the skirting boards.

Fig. 22 – Fig. 24

To take a plank row back out again, lift the entire row, levering it at the side out of the last row. You can then separate the short ends of the planks by angling them. This way, the locking system remains intact and the planks can be refitted.

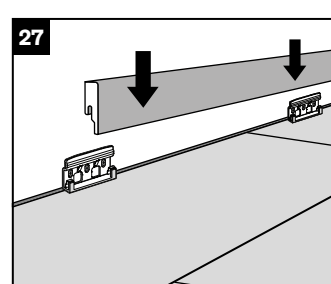
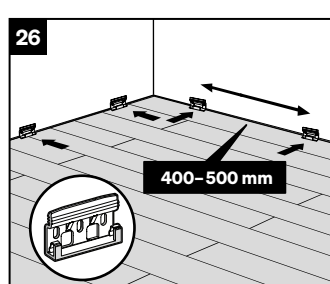
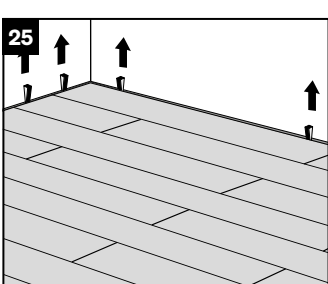
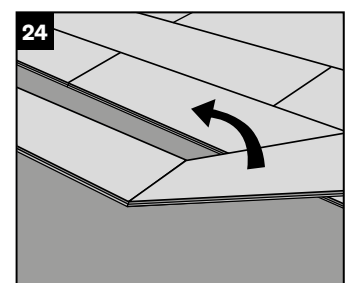
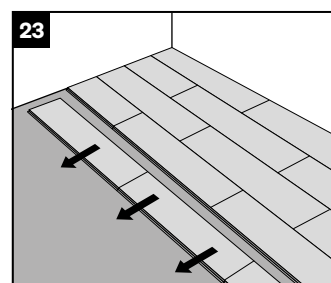
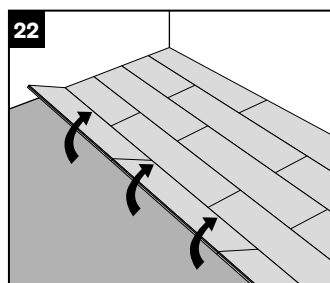
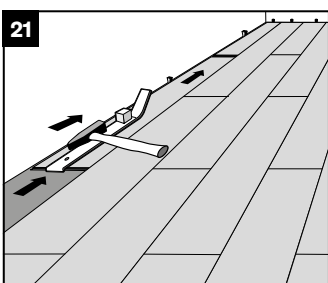
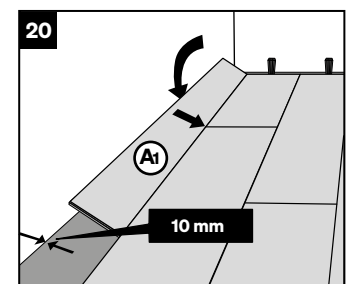
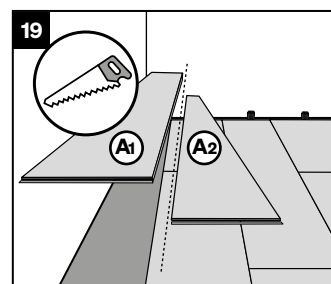
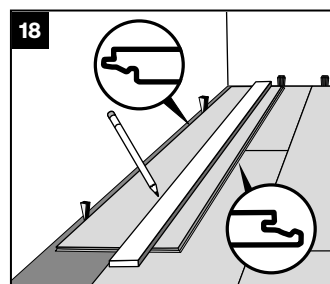
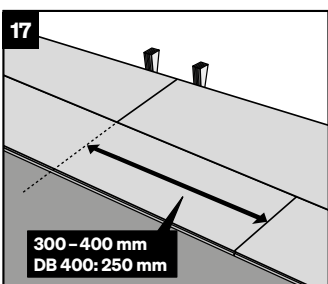
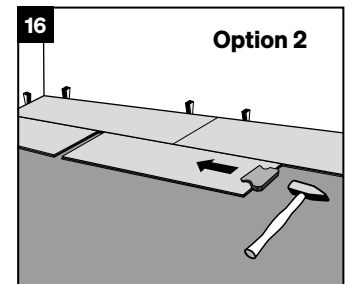
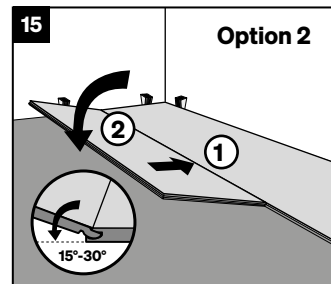
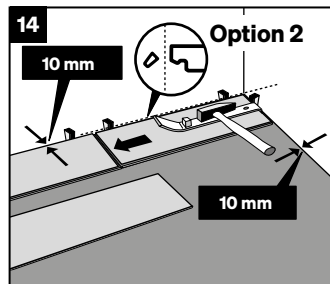
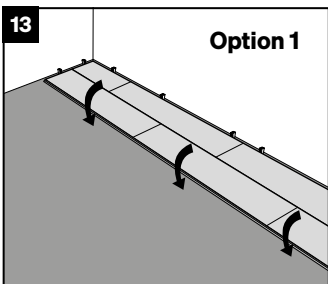
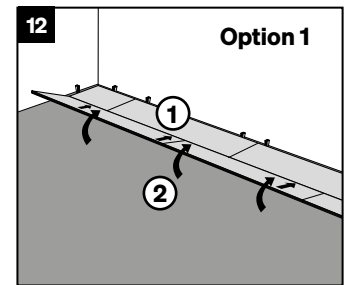
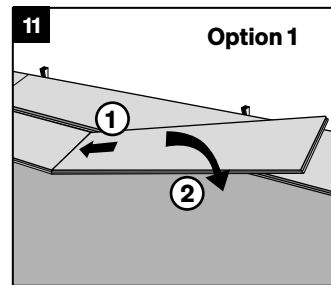
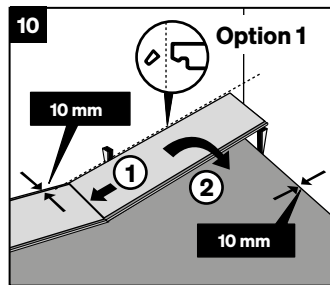
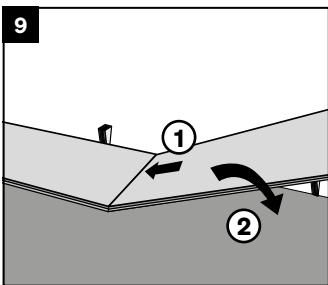
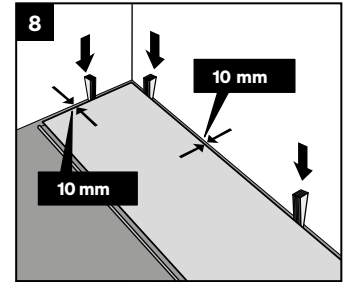
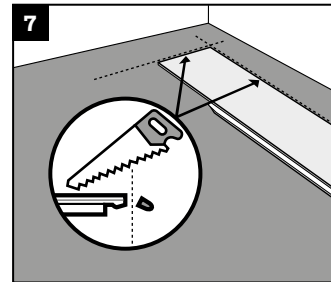
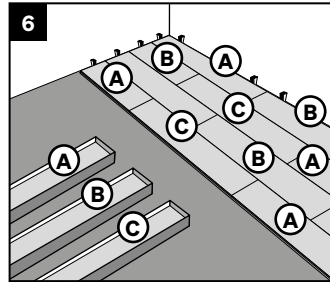
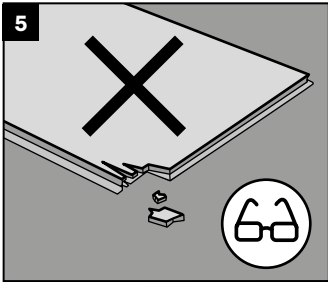
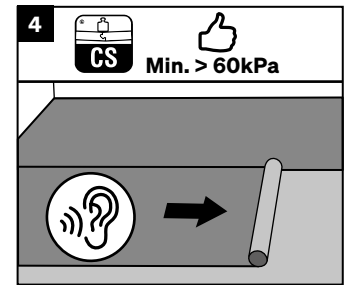
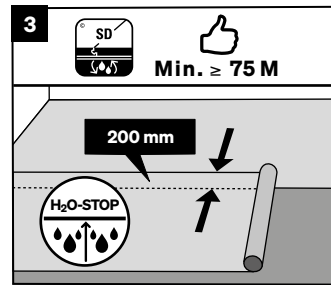
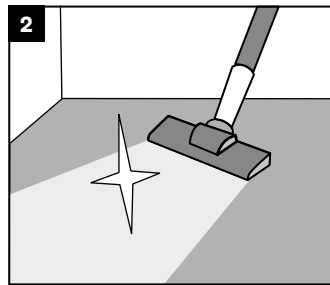
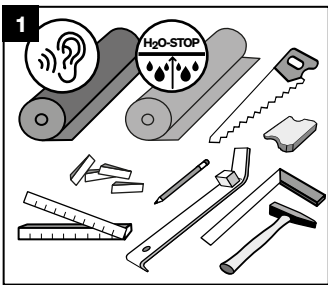

Design flooring **MeisterDesign**. rigid and **MeisterDesign**. allround with Multiclic technology



Fig. 1

The following tools and aids are required to install MEISTER design flooring MeisterDesign. rigid and MeisterDesign. allround with Multiclic technology:

Hammer, installation knife with trapezoidal blade, keyhole or electric saw, possibly power drill, folding metre rule, pencil, wedges (spacer wedges), heel bar, angle or adjustable bevel, MEISTER 5 mm tapping block-

If you are using products without sound-absorbing Silence cushioning, use the system-specific MEISTER insulating underlay Silence-Compact (CS value >400 kPa). Other types of insulating underlay must meet the increased requirements in accordance with the TM 1 briefing sheet from MMFA for Class 2 (polymer) flooring.

The flooring is installed floating without glue. The specially designed click connection allows quick and easy installation. Two different installation options are available to choose from. Option 1: Angle in the head end and long side; Option 2: Angle in the long side and join the head end using the MEISTER 5 mm tapping block and several light taps with the hammer.

Fig. 2

Remove any dirt, small stones, etc. from the surface prior to installation.

Fig. 3

Before installation, check all planks in daylight for recognisable faults in colour and structure. No claims can be made for goods that have already been installed.

Fig. 4

Install a mixture of planks from different packages. You can score the planks with an installation knife (trapezoidal blade) once or twice and then fold them down. Sawing with a jigsaw or portable circular saw or snapping with a guillotine cutter is also possible. When sawing the elements, make sure you work from the correct side: if you use a bench saw, keep the decorative side facing up, if you use a keyhole or portable circular saw, keep the decorative side down.

Fig. 5

Start by laying the first complete plank in the left-hand corner of the room with the tongue sides facing the wall. Saw the tongues off the first plank, both on the short and the long side. Remove only the tongues on the long sides of all the other planks you want to lay in the first row.

Fig. 6

Using wedges, you can easily keep a gap of at least 10 mm from the wall.

Fig. 7

Angle the short end of the next complete plank into plank 1. Install the other planks in this row in exactly the same way across the entire width of the room.

Fig. 8 – Fig. 10

The last planks in each row are cut to size so that a gap of at least 10 mm to the wall is taken into account. You can score the planks with an installation knife (trapezoidal blade) once or twice and then fold them down. You can use cut-off pieces of planks to start subsequent rows.

Option 1

Make sure that the planks in the first row are straight. Cut the first plank of the second row down to approx. 80 cm (or, for MeisterDesign. rigid RB 400 S, 50–60 cm).

Fig. 11

Angle the short end of the next complete plank into the previous plank.

Fig. 12 + Fig. 13

Once you have angled in all of the planks in a row, angle them into the previously laid row and press them down slowly using a forward and downward turning motion. The row of planks should click into the previously installed row. Alternatively, you can angle in the short end of each individual plank first and then connect the long side by slightly raising it and angling it into the previous row. Continue the installation row by row in this way.

Option 2

Fig. 15

Cut the first plank of the second row down to approx. 80 cm. Angle this plank with the tongue into the groove side of the previous row of planks and press the plank down slowly using a forward and downward turning motion. The plank should click into the previously installed row.

Fig. 16

Again, angle the next complete plank of the second row first on its long edge against the previously laid row. Make sure the long joint is always tight.

Fig. 17

Once you have angled in the plank so it lies flat on the subfloor, click the head ends together using the MEISTER 5 mm tapping block and light taps with the hammer. Continue the installation row by row in this way.

Fig. 18

Remember that the end joints must always be offset by at least 30–40 cm (or, for MeisterDesign. rigid RB 400 S, 25 cm).

Fig. 19 + Fig. 20

The last planks in each row are cut to size so that a gap of at least 10 mm to the wall is taken into account. Lay the plank with the tongue side facing the wall to mark the remaining plank width.

Fig. 21

Start by laying the last row in the right-hand corner of the room and angle the long side of the plank into the second-last row.

Fig. 22

The next plank is angled in along the long side and lowered down in the same way. The short-end connection is then established with the help of a heel bar and several light taps with the hammer.

Fig. 26

Next, remove the wooden wedges from around the walls.

Fig. 27

Screw the skirting board clips to the wall at intervals of 40–50 cm. To ensure that the skirting board fits tightly, do not position it on an uneven wall.

Fig. 28

The skirting board is placed on the clip from above and pressed down. For the length joints of the skirting boards, the clip is placed on the joint with a half overlap to ensure a good hold. Please avoid bringing any silicone products into contact with the skirting boards.

Fig. 23 – Fig. 25

To take a plank row back out again, lift the entire row, levering it at the side out of the last row. You can then separate the short ends of the planks by angling them. This way, the locking system remains intact and the planks can be refitted.

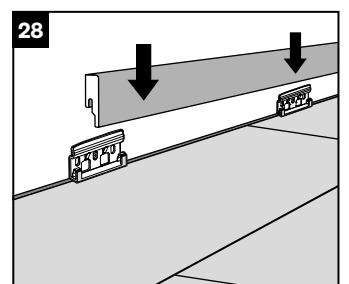
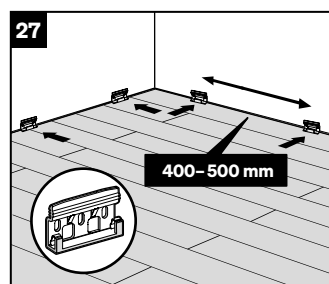
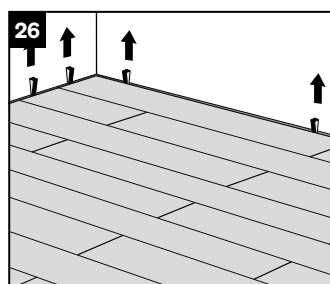
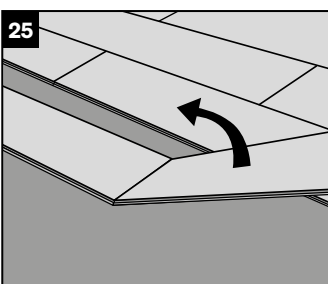
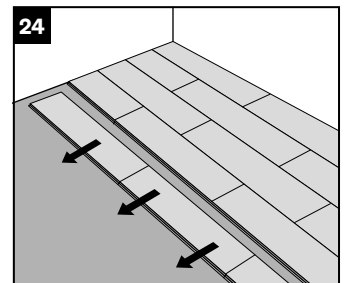
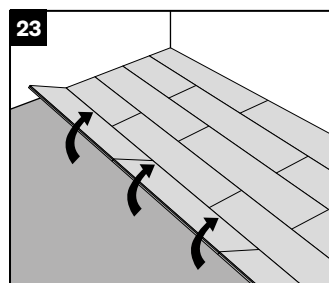
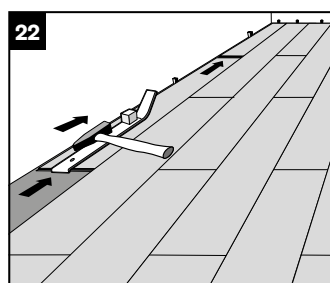
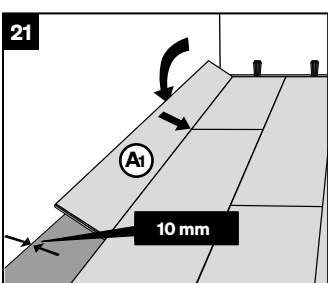
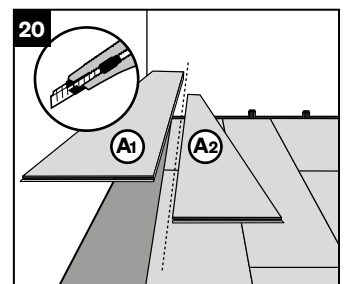
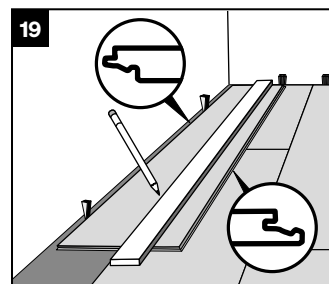
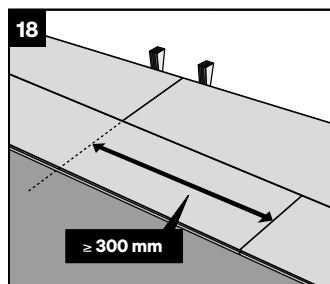
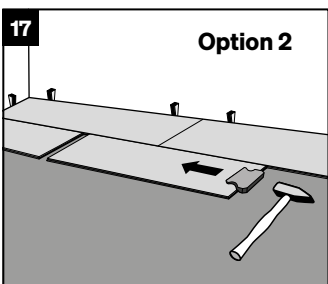
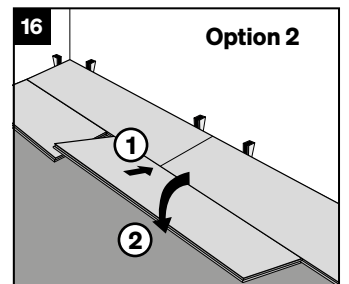
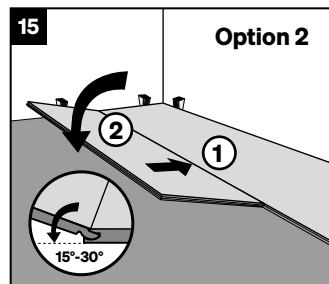
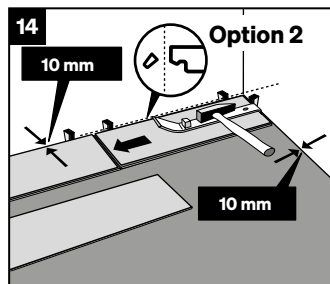
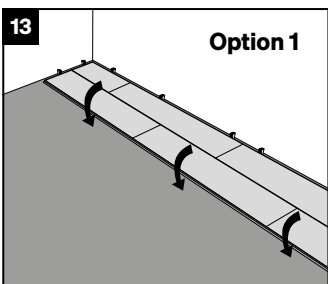
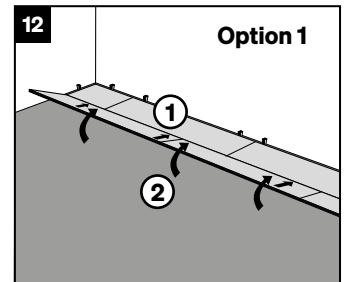
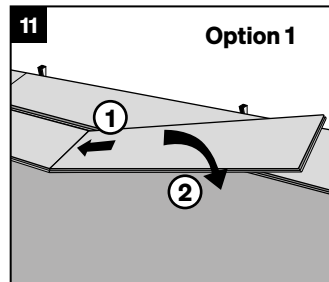
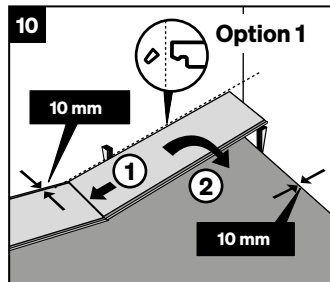
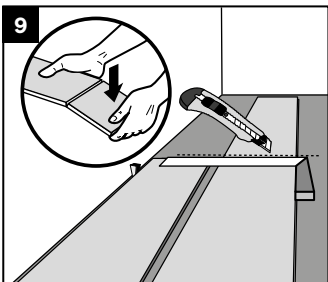
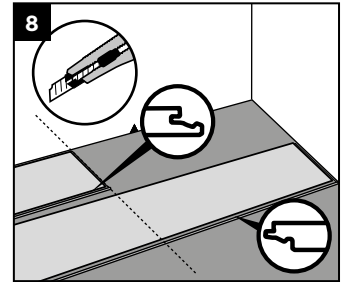
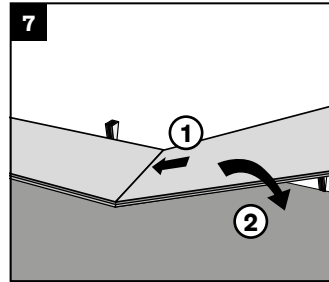
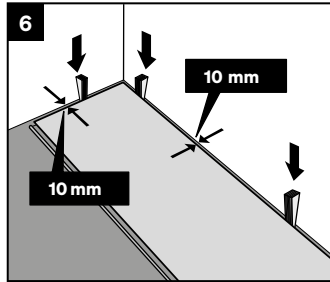
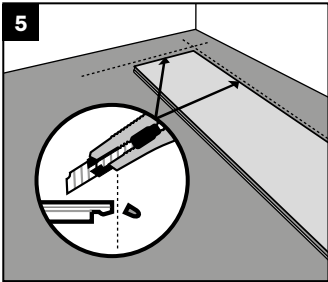
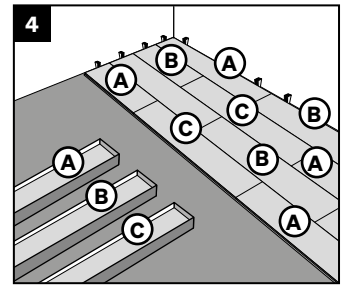
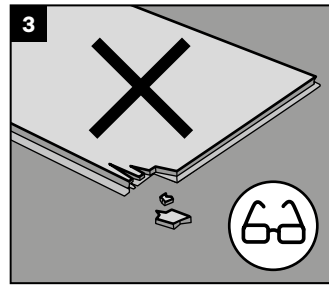
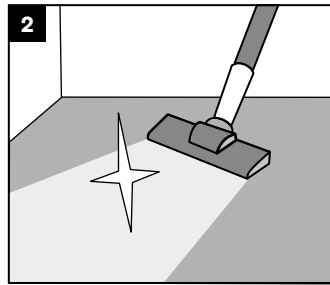
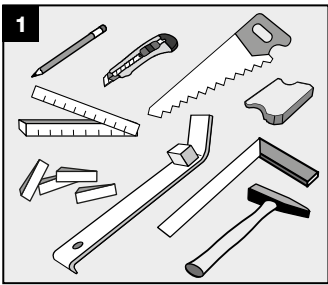

MeisterDesign. allround, MeisterDesign. pro, MeisterDesign. rigid, MeisterDesign. flex, MeisterDesign. comfort, MeisterDesign. next, Lindura® wood flooring (except HS 500), wood flooring Natureflex, MeisterParquet. longlife (except PS 500), and MeisterDesign. laminate (except LC 55 / LD 55) in humid rooms

The installation instructions for Masterclit Plus, 5G™ Dry™ or Multiclic technology (see pages 6 to 27) and the general notes and preparatory measures must be observed.

The term ‘humid rooms’ (Class W0-I) refers to all rooms with higher but not permanent moisture and/or with periodically high humidity, e.g. bathrooms. This does not include outdoor areas and wet rooms, e.g. saunas, shower cubicles, steam rooms and rooms with a floor drain.

Please note:

For MeisterParquet. longlife PD 450, PD 400, PS 300, PC 200, wood flooring Natureflex, MeisterDesign. next, MeisterDesign. flex, MeisterDesign. comfort, MeisterDesign. laminate LL 150, LC 150, LD 150, LB 150, LD 200, LS 350:

Do not leave puddles of water/spills to dry on the surface; wipe them dry within 4 hours.

Lindura wood flooring HD 400, MeisterDesign. next, MeisterDesign. laminate LL 250, LD 250:

Do not leave puddles of water/spills to dry on the surface; wipe them dry within 24 hours.

For Lindura wood flooring and MeisterParquet. longlife with a naturally oiled surface, it is essential to apply a preliminary care oil, e.g. Dr. Schutz Premium Care Oil, after installation. Going forward, the flooring should then be oiled depending on how regularly it is used – usually once a year.

In addition, any parts of the flooring that come into contact with sanitary cleaners, chemicals, etc. must be wiped with clear water without delay.

Care must always be taken that no humidity gets under the flooring. **In the case of Lindura wood floor HD 400, wood flooring Natureflex and MeisterParquet. longlife, we recommend using full-surface bonding**, in which case the wall ends and edge areas must be sealed with plasticiser-free silicone or natural stone silicone, for example. Structural measurements also have to be taken for floating installations.

Edge joints are generally necessary to guarantee the flooring can expand, particularly in rooms with high humidity.

Fig. 1 – Fig. 2

Wall ends and edge areas should preferably be fitted with suitable end, transition or joining profiles made of aluminium. To ensure the necessary seal against liquids, a pre-compressed PE sealing tape without plasticisers can be used, for example. This tape is glued under the cover profile. Once this has been screwed to the base profile, the result is a sealed finish with the flooring. The bottom profile must be glued to the adhesive and sealing tape of the respective sound-absorbing cushion.

Fig. 3 – Fig. 4

Joints between the profile and the wall must be impermeably sealed using a permanently flexible sealing compound (plasticiser-free silicone). This also applies to the wall and edge areas where none of the above-mentioned aluminium profiles can be used. In such areas, a PE joint filler cord (plasticiser-free) must be used to finish off. These expansion joints must also be sealed with sealing compound to prevent humidity penetration. Joints in the edge and wall area must always have a width of 10 mm to fixed building structures. **This is a maintenance joint which, as a flexible joint, requires permanent maintenance and care. The term ‘maintenance joint’ is used for all joints that are exposed to heavy chemical and/or physical influences and whose sealants must be checked at regular intervals and renewed if necessary in order to avoid consequential damage.**

With end profile

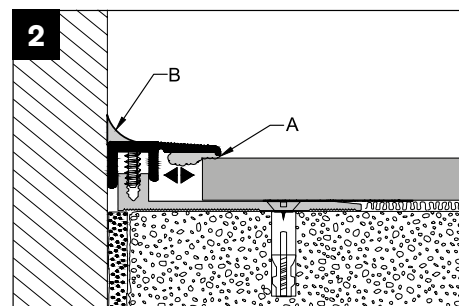
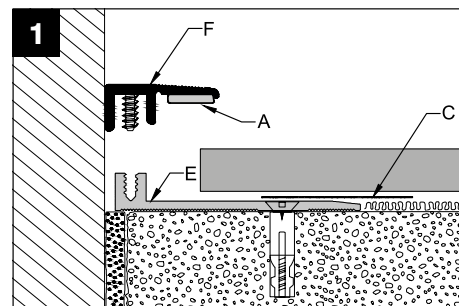

Without end profile

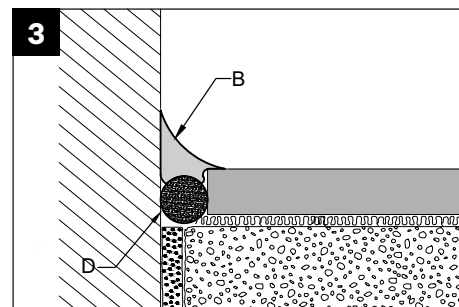

With waterproof 20 PK Aqua skirting board profile

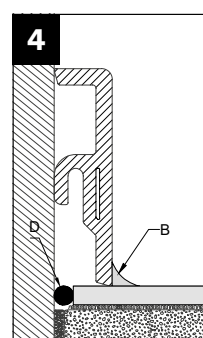

- A – Pre-compressed and plasticiser-free PE sealing tape
- B – Maintenance joint, permanently flexible, plasticiser-free silicone
- C – Adhesive tape for sound-absorbing cushion
- D – PE joint filler cord, plasticiser-free
- E – Bottom profile
- F – Cover profile

Briefing sheet

Home conservatories / floor-to-ceiling windows

Home conservatories are conservatories designed for year-round use as a recreation room, meaning they have to be capable of being heated to comfortable temperatures (more than 19° C). This means that, even in winter, the temperature must **not fall below 15° C**.

Solar heating in summer as well as through south-facing windows is limited by natural shading and/or structural measures such as ventilation, suitable glazing and sun protection depending on the local conditions and orientation of the space to avoid excessive temperature fluctuations in the floor.

The surface temperature of the floor must not permanently exceed 29° C.

The climatic conditions in the room also have to be taken into account:

- | Climate during installation: The room air temperature should be 20° C (at least 15° C) with a relative humidity of 30–65%
- | Permanent indoor climate: Room air temperature of 18–22° C, relative humidity of 30–65%

The flooring may only be installed on a subfloor that complies with the specifications of DIN 18 356 'Laying of parquet' and DIN 18 365 'Flooring works'.

- | The substructure is permanently protected against rising damp from the ground.
- | The substructure is insulated in a way that precludes damage due to temperature differences or condensation.
- | In the case of screeds, the residual moisture values must be checked and maintained by taking CM measurements prior to laying:
 - | Heated/unheated cement screed: 1.8 CM% / 2.0 CM%,
 - | Heated/unheated calcium sulphate screed: 0.3 CM% / 0.5 CM%
- | The limit values when carrying out the CRH method are 80 per cent relative humidity for unheated screeds and 75 per cent relative humidity for heated screeds (TKB briefing sheet 18; DIN EN 17668)
- | The subfloor must be checked to ensure it is ready for installation. Above all, this must be smooth, dry, clean, free of cracks and release agents, and able to withstand lifting and pressing force.

If a levelling compound is applied to the subfloor, then it is essential to observe the prescribed climatic conditions for the room, the necessary subfloor preparation (sanding, priming, etc.) and the drying times.

Before opening the packages, leave them to acclimatise until they have adjusted to room temperature. Store them for approx. 48 hours (approx. 3–4 days in winter) unopened and flat on the floor in the centre of the room you want to work in.

For full-surface bonding, it is essential to observe the manufacturer's requirements (regarding climatic conditions for the room, open time, sufficient quantity of the suitable adhesive, etc.).

The colour-fastness of MEISTER flooring (with the exception of parquet, Lindura wood flooring and wood flooring Natureflex) is tested in accordance with test standard EN ISO 105-B02 and conforms to the highest requirements. Nevertheless, the possibility of colour changes due to strong and persistent solar radiation cannot be excluded.

The product-specific installation instructions must be observed.

Flooring profiles

If the floor area is longer or wider than 10 metres (12 metres for MeisterDesign. allround and MeisterDesign. laminate LD 250, LL 200 and LL 250, and 15 metres for MeisterDesign. rigid), then you must provide an expansion joint. This is covered with a transition profile. Please also be aware of this in doorways, passageways and rooms with many angles (MeisterDesign. rigid and MeisterDesign. allround can be laid in door

areas without a transition profile). Use the joining profile to adjust to adjacent, lower-lying areas or flooring. The end profile is ideal for clean transitions to adjacent, higher thresholds, tiles or similar.

Stairs that are laid with MEISTER flooring have a clean finish with the stair edge profile.

**Joining, end and transition profiles, anodised aluminium, matching all MEISTER flooring
(except for: MeisterDesign. rigid, MeisterDesign. flex and MeisterDesign. allround design flooring)**

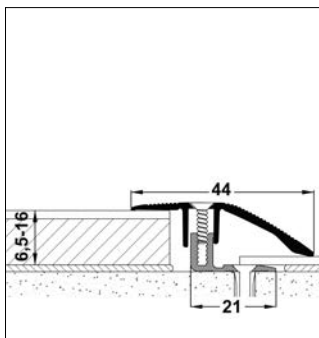

**Joining profile type 200
(6.5 to 16 mm)**
Acts as a crossover between adjacent, lower-lying areas or flooring (e.g. carpet or linoleum)

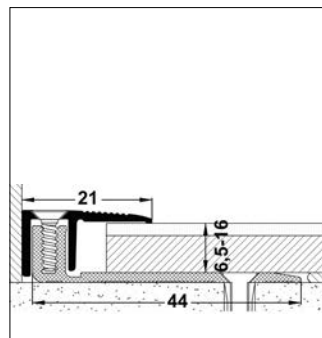

**End profile type 201 B
(6.5 to 16 mm)**
Broad bottom profile allows better fixing to subfloor.

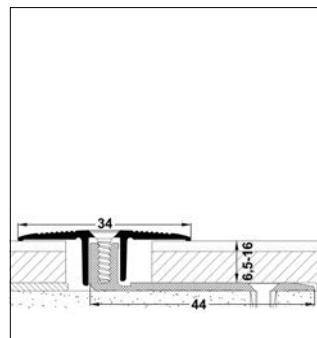

**Transition profile type 202 B
(6.5 to 16 mm)**
Broad bottom profile allows better fixing to subfloor. For expansion joints: Height differences of up to 3 mm can be bridged.

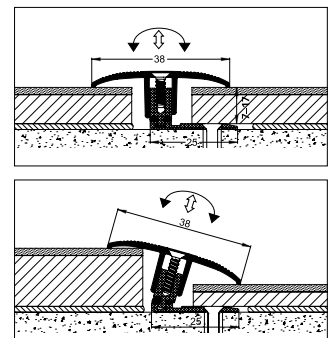

**Flexo transition profile type 302
(7 to 17 mm)**
For expansion joints: Suited for flooring measuring between 7 and 17 mm (at equal covering height). Height differences of up to 12 mm (e.g. from 23 mm to 8 mm or from 15 mm to 3 mm) can be bridged.

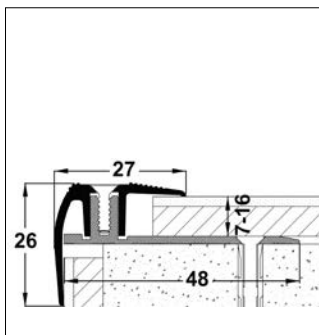

**Stair edge profile type 203
(7 to 16 mm)**
Supplied as a 2-part profile system (cover and base element). Screws provided.

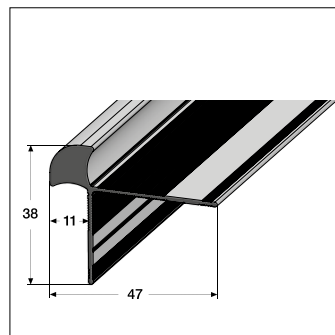

**Stair edge profile type 11
(10 to 11 mm)**
Two-sided; discreet, visible edge; drilled countersunk, with grooves.

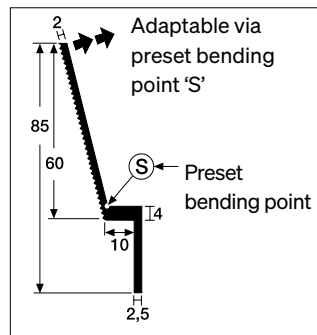

Sloping angle 3402
With adhesive grooves; natural-coloured aluminium; with countersunk drill holes; 3.5 Ø × 20 mm wood screws with cross-slot head are provided. Toughness: approx. 75 N/mm². Length: 100 cm

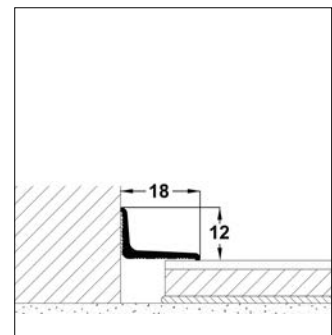

**End profile type 300 SK
(self-adhesive)**
For clean finishes with patio doors and floor-to-ceiling windows.

Joining, end and transition profiles, anodised aluminium, matching all MEISTER design flooring – MeisterDesign. flex, MeisterDesign. rigid and MeisterDesign. allround

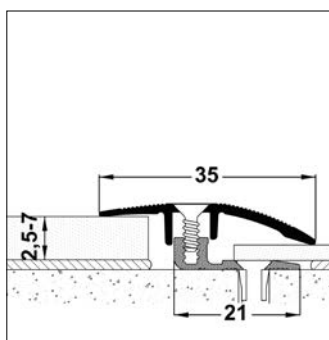

**Joining profile type 100
(2.5 to 7 mm)**
Acts as a crossover between adjacent, lower-lying areas or flooring (e.g. carpet or linoleum)

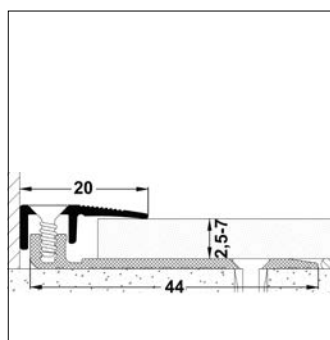

**End profile type 101
(2.5 to 7 mm)**
For clean transitions to adjacent, higher thresholds, tiles, patio doors, floor-to-ceiling windows or similar.

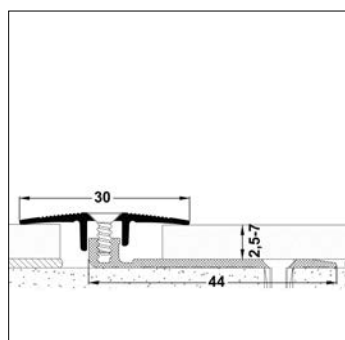

**Transition profile type 102
(2.5 to 7 mm)**
For expansion joints. Height differences of up to 3 mm can be bridged.

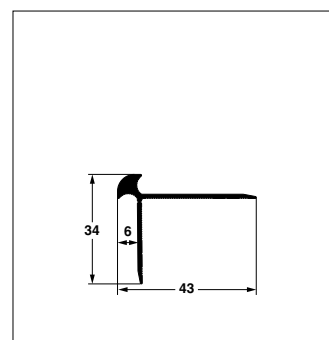

**Stair edge profile type 5
(5 to 6 mm)**
Two-sided; discreet, visible edge; drilled countersunk, with grooves.

Transition profile type 335 SK (self-adhesive) covered in specially coated laminate film or anodised aluminium, matching all MEISTER flooring

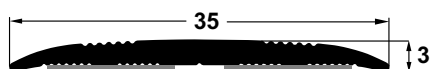

Wall transitions / Skirting boards

To cover the expansion joints around the edges of MEISTER laminate flooring, use MEISTER skirting board 3 PK and 5 PK profiles. For LB 150, we recommend MEISTER skirting board 8 PK profiles with colour-matching decorative surfaces. When installing MEISTER Longlife parquet and MEISTER Lindura wood flooring, we offer matching real wood veneered MEISTER skirting board 3 PK profiles.

When installing MEISTER design flooring, use the MEISTER skirting board 20 PK, 20 PK Aqua and 8 PK profiles with colour-matching decorative surfaces. The MEISTER profile skirting boards are a clean and sophisticated floor connector and can be fitted with a clip, glued (with silicone-free assembly adhesive), nailed or screwed.

A hollow space inside the attachment clips (PK) makes it possible to partially conceal cables. Please avoid bringing any silicone products into contact with the skirting boards.

Skirting boards – a perfect finish

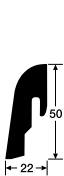

Skirting board
2 PK profile



Skirting board
3 PK profile



Skirting board
5 PK profile

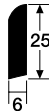

Skirting board
6 profile



Quarter round
7 profile



Skirting board
8 PK profile



Skirting board
9 PK profile

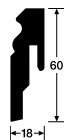

Skirting board
10 PK profile
10 F MK profile



Skirting board
11 PK profile
11 F MK profile



Skirting board
12 PK profile
12 F MK profile



Skirting board
13 PK profile



Skirting board
14 MK profile
14 F MK profile

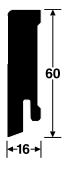

Skirting board
15 MK profile
15 F MK profile



Skirting board
16 MK profile

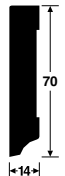

Skirting board
17 profile



Skirting board
18 PK profile



Skirting board
19 PK profile

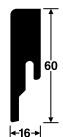

Skirting board
20 PK profile



Skirting board
20 PK Aqua profile

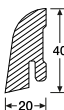

Skirting board
21 F MK profile

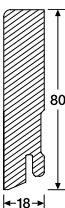

Skirting board
22 F MK profile

PK / MK profiles:
MDF base material
(PK Aqua: polystyrene base material)

F MK profiles:
Spruce base material

Underlay materials

Thanks to their special PUR mineral blend, MEISTER-Silence 25 DB, MEISTER-Silence 20 and MEISTER-Silence 15 DB offer the ideal insulating underlay for effective room and footfall noise protection. The high net weight of the products also further improves their sound-absorbing properties. In the case of Silence 25 DB and 15 DB, the moisture-resistant barrier is already integrated, which means there is no need to lay an additional moisture protection film on mineral subfloors.

The MEISTER-Silence Compact insulating underlay is a 1.5 mm thick underlay made of a PUR mineral blend. It has been specially developed for flooring with a solid, elastic and synthetic core with a click system. These underlays meet the increased requirements of the technical briefing sheet issued by the MMFA (Multilayer Modular Flooring Association) for Class 2 flooring. All MEISTER underlay materials can be installed on underfloor heating.

They comply with the technical briefing sheet provided by the European Producers of Laminate Flooring (EPLF) based on CEN/TS 16354. The Silence products also meet the requirements of the technical bulletin issued by the Multilayer Modular Flooring Association (MMFA): 'Underlay Materials under Multilayer Modular Floor Coverings (MMF) – Test Standards and Performance Indicators' for Class 1 (with HDF core).

Product properties – underlay materials

	Silence 25 DB	Silence 20	Silence 15 DB	Silence Compact	Silence Eco	Twin Control	Foam film	Plastic (PE) film
Material thickness approx.	3 mm	2.5 mm	2 mm	1.5 mm	3 mm	2 mm	2 mm	0.2 mm
Weight approx.	2.5 kg/m ²	2 kg/m ²	1.6 kg/m ²	1.5 kg/m ²	0.8 kg/m ²	0.3 kg/m ²	0.2 kg/m ²	
Pressure resistance	approx. 130 kPa ••••	approx. 150 kPa ••••	approx. 220 kPa •••••	approx. 450 kPa •••••	approx. 150 kPa ••••	ca. 60 kPa •••	ca. 70 kPa •••	–
Room noise improvement	•••••	••••	•••	•••	••	••	••	–
Footfall noise improvement	••••	••••	•••	•••	••••	•••	•••	–
Suitability for underfloor heating	••••	••••	••••	••••	••	••	••	•••••
Suitability for underfloor cooling	••••	••••	••••	••••	–	–	–	•••••
Correction of unevenness	••••	••••	•••	••	•••	•••	•••	–
Humidity protection	✓	No	✓	No	No	✓	No	✓

Recommendations for use

Subfloor	Silence 25 DB	Silence 20	Silence 15 DB	Silence Compact	Silence Eco	Twin Control	Foam film	Plastic (PE) film
Wooden planks	–	×	–	×	×	–	×	–
Wood based boards, OSB boards, drywall elements	–	×	–	×	×	–	×	–
Mineral subfloors (e.g. cement screed, anhydride screed)	×	× with plastic (PE) film	×	× with plastic (PE) film	× with plastic (PE) film	×	× with plastic (PE) film	×
Mastic asphalt screed	–	×	–	×	×	–	×	–
Existing coverings (e.g. ceramic tiles and boards, natural stone, plastic)	×	× with plastic (PE) film	×	× with plastic (PE) film	× with plastic (PE) film	×	× with plastic (PE) film	×
PVC/linoleum web material	–	×	–	×	×	–	×	–

Properties:

••••• Ideally suited •••• Very well suited ••• Well suited •• Suited • Suited to a certain extent ✓ Available × Suited – Not suited

Parquet flooring on hot-water underfloor heating structures

The entire MeisterParquet. longlife range is suitable for installation over controlled hot-water underfloor heating.

Please follow the instructions below:

All MeisterParquet. longlife products offer a thermal resistance of 0.118 m² K/W when used with MEISTER Silence 25 DB. Due to the natural warmth of the flooring, the underfloor heating can be switched off more often during moderately cold weather compared to heating under tiled floors. MEISTER flooring on underfloor heating also reaches an even surface temperature all over. All types of wood are suitable for installation on hot-water underfloor heating. Open joints may appear due to the natural swelling and shrinking properties of natural woods. Maple and beech are notably more sensitive in this regard. The flooring must not be covered with items such as carpets, runners, mats or any other overlays, as these may cause an accumulation of heat. These types of flooring react by deforming and warping.

When laying on hot-water underfloor heating in commercial areas, we recommend the installation of a fidbox® (measuring device from floorprotector).

Preparatory measures

Any room heated over a large area requires planning and coordination of the heating system, the screed and the various coverings, taking into account the type of use, in order to ensure optimum and fault-free functioning over the long term. When these special floor constructions are installed, professional standards are correspondingly important. Supplies and processing steps must comply with the generally recognised rules of technology, the briefing sheets available from the central association of the German construction trade, and the assembly and installation guidelines of the relevant system suppliers and manufacturers.

Attention! In the case of underfloor heating, the bottom profiles of the transition rails, etc. are fixed with construction adhesive.

Screed – Moisture check – Readiness for laying

Once the screed has been produced and allowed to lie for a suitable period of time, it can then be heated. Complete drying out (readiness for laying) is an absolute prerequisite for the preparation and installation steps for MeisterParquet. longlife parquet flooring and is therefore essential. The reason for this is that the moisture measurements to be carried out as part of the subsurface check cannot be reliably performed on heated constructions due to the risk of damage. This means that heated screed must be dried out by means of heating up and cooling down with a heating break before installation of any type of covering. To be ready for the installation of MEISTER flooring, the moisture content (maximum moisture values according to VOB Part C, DIN 18365) of cement screed should be a maximum of 1.8 CM%, or a maximum of 0.3 CM% for anhydrite screed. The limit values when carrying out the CRH method are 80 per cent relative humidity for unheated screeds and 75 per cent relative humidity for heated screeds

(TKB briefing sheet 18; DIN EN 17668).

The moisture content limits also apply to fast-hardening cement and screed with screed additives – TKB briefing sheet 14.

Special measures

(heating up and cooling down)

The client must observe the following instructions and/or ensure they are followed by the persons responsible:

- | The screed with underfloor heating must be heated up after its respective holding time in accordance with its specific data sheet.
- | While heating up, the initial temperature should be increased daily up to the full (maximum) heating power.
- | The pattern of the heating measure and the heating break must be carried out in accordance with the measure protocol.
- | The time plan indicates the minimum period of heating up – each additional day is of further benefit and provides extra security.
- | MeisterParquet. longlife must be installed in accordance with DIN 18356, 18365 and 18367 at a screed surface temperature of at least 15°C and a maximum relative humidity of 30–65%.
- | After installation of the flooring (completion), this climate must be maintained for one week (adhering and hardening time of adhesives and other material layers used).
- | After installation of MeisterParquet. longlife, the maximum surface temperature of 29°C must not be exceeded.

Important: The above points must be carried out according to the relevant rules and/or confirmed by specialists (architect, heating specialist, etc.).

Structure of the floating installation

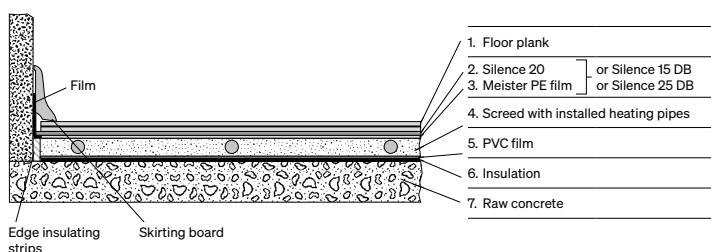

Structure of the full-surface bonding

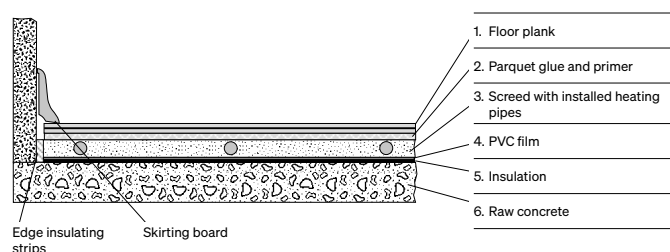

Note: Full-surface bonding must be carried out by a professional.

Lindura wood flooring on hot-water underfloor heating structures

The MEISTER Lindura wood flooring is suitable for installation on hot-water underfloor heating.

Please follow the instructions below:

When installed with MEISTER-Silence 25 DB, MEISTER Lindura wood flooring has a thermal resistance of 0.084 m² K/W.

Due to the natural warmth of the flooring, the heating can be switched off more often during moderately cold weather compared to heating under tiled floors. MEISTER flooring on underfloor heating also reaches an even surface temperature all over. The flooring must not be covered with items such as carpets, runners, mats or any other overlays, as these may cause an accumulation of heat. These types of flooring react by deforming and warping. When laying on hot-water underfloor heating in commercial areas, we recommend the installation of a fidbox* (measuring device from floor- protector).

Preparatory measures

Any room heated over a large area requires planning and coordination of the heating system, the screed and the various coverings, taking into account the type of use, in order to ensure optimum and fault-free functioning over the long term. When these special floor constructions are installed, professional standards are correspondingly important. Supplies and processing steps must comply with the generally recognised rules of technology, the briefing sheets available from the central association of the German construction trade, and the assembly and installation guidelines of the relevant system suppliers and manufacturers.

Attention! In the case of underfloor heating, the bottom profiles of the transition rails, etc. are fixed with construction adhesive.

Screed – Moisture check – Readiness for laying

Once the screed has been produced and allowed to lie for a suitable period of time, it can then be heated. Complete drying out (readiness for laying) is an absolute prerequisite for the preparation and installation steps for MEISTER Lindura wood floor and is therefore essential. The reason for this is that the moisture measurements to be carried out as part of the subsurface check cannot be reliably performed on heated constructions due to the risk of damage.

This means that heated screed must be dried out by means of heating up and cooling down with a heating break before installation of any type of covering. To be ready for the installation of MEISTER flooring, the moisture content (maximum moisture values according to VOB Part C, DIN 18365) of cement screed should be a maximum of 1.8 CM%, or a maximum of 0.3 CM% for anhydrite screed. The limit values when carrying out the CRH method are 80 per cent relative humidity for unheated screeds and 75 per cent relative humidity for heated screeds (TKB briefing sheet 18; DIN EN 17668). The moisture content limits also apply to fast-hardening cement and screed with screed additives – TKB briefing sheet 14.

Special measures

(heating up and cooling down)
The client must observe the following instructions and/or ensure they are followed by the persons responsible:

- | The screed with underfloor heating must be heated up after its respective holding time in accordance with its specific data sheet.
- | While heating up, the initial temperature should be increased daily up to the full (maximum) heating power.
- | The pattern of the heating measure and the heating break must be carried out in accordance with the measure protocol.
- | The time plan indicates the minimum period of heating up – each additional day is of further benefit and provides extra security.
- | MEISTER Lindura wood flooring must be installed in accordance with DIN 18356, 18365 and 18367 at a screed surface temperature of at least 15°C and a maximum relative humidity of 30–65%.
- | After installation of the flooring (completion), this climate must be maintained for one week (adhering and hardening time of adhesives and other material layers used).
- | After installation of MEISTER Lindura wood flooring, the maximum surface temperature of 29°C must not be exceeded.

Important: The above points must be carried out according to the relevant rules and/or confirmed by specialists (architect, heating specialist, etc.).

Structure of the floating installation

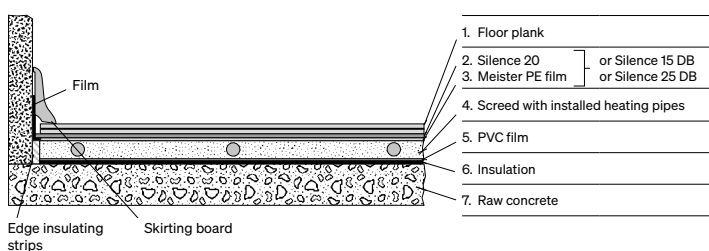

Structure of the full-surface bonding

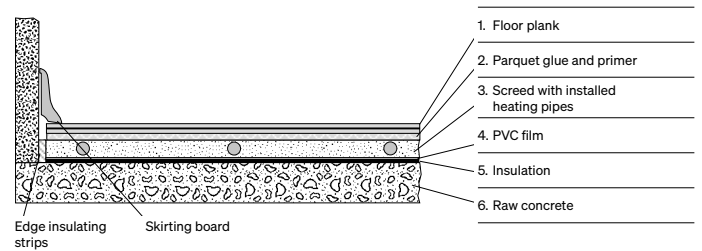

Note: Full-surface bonding must be carried out by a professional.

Wood flooring Natureflex on hot-water underfloor heating structures

The MEISTER wood flooring is suitable for installation on hot-water underfloor heating.

Please follow the instructions below:

When installed with MEISTER-Silence 15 DB, MEISTER wood flooring Natureflex has a thermal resistance of 0.0666 m² K/W. Due to the natural warmth of the flooring, the heating can be switched off more often during moderately cold weather compared to heating under tiled floors. MEISTER flooring on underfloor heating also reaches an even surface temperature all over. The flooring must not be covered with items such as carpets, runners, mats or any other overlays, as these may cause an accumulation of heat. These types of flooring react by deforming and warping.

When laying on hot-water underfloor heating in commercial areas, we recommend the installation of a fidbox® (measuring device from floor-protector).

Preparatory measures

Any room heated over a large area requires planning and coordination of the heating system, the screed and the various coverings, taking into account the type of use, in order to ensure optimum and fault-free functioning over the long term. When these special floor constructions are installed, professional standards are correspondingly important. Supplies and processing steps must comply with the generally recognised rules of technology, the briefing sheets available from the central association of the German construction trade, and the assembly and installation guidelines of the relevant system suppliers and manufacturers.

Attention! In the case of underfloor heating, the bottom profiles of the transition rails, etc. are fixed with construction adhesive.

Screed – Moisture check – Readiness for laying

Once the screed has been produced and allowed to lie for a suitable period of time, it can then be heated. Complete drying out (readiness for laying) is an absolute prerequisite for the preparation and installation steps for MEISTER wood flooring and is therefore essential. The reason for this is that the moisture measurements to be carried out as part of the subsurface check cannot be reliably performed on heated constructions due to the risk of damage.

This means that heated screed must be dried out by means of heating up and cooling down with a heating break before installation of any type of covering. To be ready for the installation of MEISTER flooring, the moisture content (maximum moisture values according to VOB Part C, DIN 18 365) of cement screed should be a maximum of 1.8 CM%, or a maximum of 0.3 CM% for anhydrite screed. The limit values when carrying out the CRH method are 80 per cent relative humidity for unheated screeds and 75 per cent relative humidity for heated screeds (TKB briefing sheet 18; DIN EN 17 668). The moisture content limits also apply to fast-hardening cement and screed with screed additives – TKB briefing sheet 14.

Special measures

(heating up and cooling down)

The client must observe the following instructions and/or ensure they are followed by the persons responsible:

- | The screed with underfloor heating must be heated up after its respective holding time in accordance with its specific data sheet.
- | While heating up, the initial temperature should be increased daily up to the full (maximum) heating power.
- | The pattern of the heating measure and the heating break must be carried out in accordance with the measure protocol.
- | The time plan indicates the minimum period of heating up – each additional day is of further benefit and provides extra security.
- | MEISTER wood flooring must be installed in accordance with DIN 18 356, 18 365 and 18367 at a screed surface temperature of at least 15°C and a maximum relative humidity of 30–65%.
- | After installation of the flooring (completion), this climate must be maintained for one week (adhering and hardening time of adhesives and other material layers used).
- | After installation of MEISTER wood flooring, the maximum surface temperature of 29° C must not be exceeded.

Important: The above points must be carried out according to the relevant rules and/or confirmed by specialists (architect, heating specialist, etc.).

Structure of the floating installation

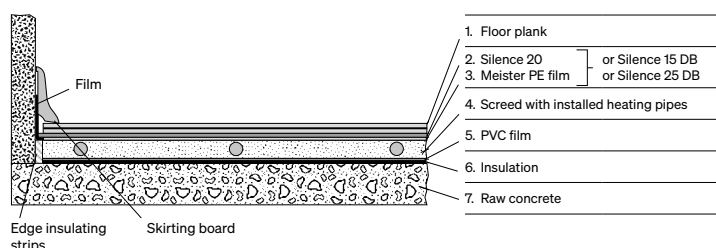

Structure of the full-surface bonding

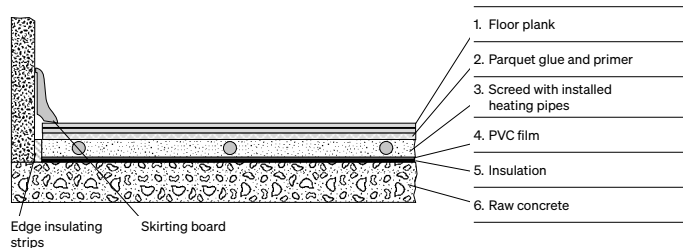

Note: Full-surface bonding must be carried out by a professional.

Design flooring on hot-water underfloor heating structures

All MEISTER design flooring is suitable for installation on hot-water underfloor heating.

Please follow the instructions below:

The DL 500 S, DD 500 S and DB 500 S collections offer a thermal resistance of 0.068 m² K/W. The DL 600 S, DD 600 S and DB 600 S offer a thermal resistance of 0.088 m² K/W. The DL 400, DD 400 and DB 400 collections offer a thermal resistance of 0.05 m² K/W when installed over MEISTER-Silence 15 DB. The RL 400 S and RB 400 S collections offer a thermal resistance of 0.05 m² K/W, while that of the RD 300 S collection offers 0.064 m² K/W, and the DD 700 S offers 0.034 m²K/W.

Due to the natural warmth of the flooring, the heating can be switched off more often during moderately cold weather compared to heating under tiled floors. MEISTER flooring on under-floor heating also reaches an even surface temperature all over.

The flooring must not be covered with items such as carpets, runners, mats or any other overlays, as these may cause an accumulation of heat. These types of flooring react by deforming and warping.

When laying on hot-water underfloor heating in commercial areas, we recommend the installation of a fidbox[®] (measuring device from floorprotector).

Preparatory measures

Any room heated over a large area requires planning and coordination of the heating system, the screed and the various coverings, taking into account the type of use, in order to ensure optimum and fault-free functioning over the long term.

When these special floor constructions are installed, professional standards are correspondingly important.

Supplies and processing steps must comply with the generally recognised rules of technology, the briefing sheets available from the central

association of the German construction trade, and the assembly and installation guidelines of the relevant system suppliers and manufacturers.

Attention! In the case of underfloor heating, the bottom profiles of the transition rails, etc. are fixed with construction adhesive.

Screed – Moisture check – Readiness for laying

Once the screed has been produced and allowed to lie for a suitable period of time, it can then be heated. Complete drying out (readiness for laying) is an absolute prerequisite for the preparation and installation steps for MEISTER design flooring and is therefore essential. The reason for this is that the moisture measurements to be carried out as part of the subsurface check cannot be reliably performed on heated constructions due to the risk of damage. This means that heated screed must be dried out by means of heating up and cooling down with a heating break before installation of any type of covering. To be ready for the installation of MEISTER flooring, the moisture content (maximum moisture values according to VOB Part C, DIN 18365) of cement screed should be a maximum of 1.8 CM%, or a maximum of 0.3 CM% for anhydrite screed. The limit values when carrying out the CRH method are 80 per cent relative humidity for unheated screeds and 75 per cent relative humidity for heated screeds (TKB briefing sheet 18; DIN EN 17668).

The moisture content limits also apply to fast-hardening cement and screed with screed additives – TKB briefing sheet 14.

Special measures

(heating up and cooling down)

The client must observe the following instructions and/or ensure they are followed by the persons responsible:

- | The screed with underfloor heating must be heated up after its respective holding time in accordance with its specific data sheet.
- | While heating up, the initial temperature should be increased daily up to the full (maximum) heating power.
- | The pattern of the heating measure and the heating break must be carried out in accordance with the measure protocol.
- | The time plan indicates the minimum period of heating up – each additional day is of further benefit and provides extra security.
- | MEISTER design flooring must be installed in accordance with DIN 18356, 18365 and 18367 at a screed surface temperature of at least 15°C and a maximum relative humidity of 30–65%.
- | After installation of the flooring (completion), this climate must be maintained for one week (adhering and hardening time of adhesives and other material layers used).
- | After installation of MEISTER design flooring, the maximum surface temperature of 29°C must not be exceeded.

Important: The above points must be carried out according to the relevant rules and/or confirmed by specialists (architect, heating specialist, etc.).

Structure of the floating installation

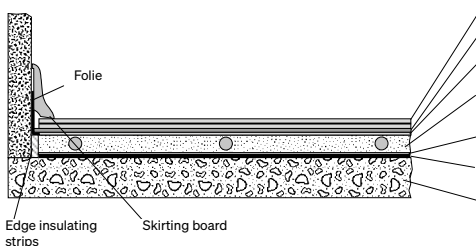

Collections: DL 400, DD 400, DB 400	DL 600 S, DD 600 S, DB 600 S, DL 500 S, DD 500 S, DB 500 S	RL 400 S, RB 400 S, RD 300 S, DD 700 S
1. Floor plank	Floor plank with sound-absorbing cushion	Floor plank with sound-absorbing cushion
2. Silence 20 3. Meister PE film	or Silence 15 DB or Silence 25 DB Meister PE film	
4. Screed with installed heating pipes	Screed with installed heating pipes	Screed with installed heating pipes
5. PVC film	PVC film	PVC film
6. Insulation	Insulation	Insulation
7. Raw concrete	Raw concrete	Raw concrete

Laminate flooring on hot-water underfloor heating structures

All MEISTER laminate flooring is suitable for installation on hot-water underfloor heating.

Preparatory measures

Any room heated over a large area requires planning and coordination of the heating system, the screed and the various coverings, taking into account the type of use, in order to ensure optimum and fault-free functioning over the long term. When these special floor constructions are installed, professional standards are correspondingly important. Supplies and processing steps must comply with the generally recognised rules of technology, the briefing sheets available from the central association of the German construction trade, and the assembly and installation guidelines of the relevant system suppliers and manufacturers. The flooring must not be covered with items such as carpets, runners, mats or any other overlays, as these may cause an accumulation of heat. These types of flooring react by deforming and warping.

Attention! In the case of underfloor heating, the bottom profiles of the transition rails, etc. are fixed with construction adhesive.

Screed – Moisture check – Readiness for laying

Once the screed has been produced and allowed to lie for a suitable period of time, it can then be heated. Complete drying out (readiness for laying) is an absolute prerequisite for the preparation and installation steps for MEISTER laminate flooring and is therefore essential. The reason for this is that the moisture measurements to be carried out as part of the subsurface check cannot be reliably performed on heated constructions due to the risk of damage. This means that heated screed must be dried out by means of heating up and cooling down with a heating break before installation of any type of covering. To be ready for the installation of MEISTER flooring, the moisture content (maximum moisture values according to VOB Part C, DIN 18365) of

cement screed should be a maximum of 1.8 CM%, or a maximum of 0.3 CM% for anhydrite screed. The limit values when carrying out the CRH method are 80 per cent relative humidity for unheated screeds and 75 per cent relative humidity for heated screeds (TKB briefing sheet 18; DIN EN 17668). The moisture content limits also apply to fast-hardening cement and screed with screed additives – TKB briefing sheet 14.

Special measures

(heating up and cooling down)

The client must observe the following instructions and/or ensure they are followed by the persons responsible:

- | The screed with underfloor heating must be heated up after its respective holding time in accordance with its specific data sheet.
- | While heating up, the initial temperature should be increased daily up to the full (maximum) heating power.

- | The pattern of the heating measure and the heating break must be carried out in accordance with the measure protocol.
- | The time plan indicates the minimum period of heating up – each additional day is of further benefit and provides extra security.
- | MEISTER laminate flooring must be installed in accordance with DIN 18356, 18365 and 18367 at a screed surface temperature of at least 15°C and a maximum relative humidity of 30–65%.
- | After installation of the flooring (completion), this climate must be maintained for one week (adhering and hardening time of adhesives and other material layers used).
- | After installation of MEISTER laminate flooring, the maximum surface temperature of 29°C must not be exceeded.

Important: The above points must be carried out according to the relevant rules and/or confirmed by specialists (architect, heating specialist etc.).

Laminate flooring heat transmitting resistance MEISTER laminate flooring on insulating underlays

	Installation on MEISTER Twin Control m ² K/W	Installation on MEISTER-Silence 25 DB m ² K/W
LL 250 / LD 250 / LS 350	–	0.071
LC 150 / LD 150 LB 150 / LL 150 / LD 200	0.115	0.07
LC 55 / LD 55	0.104	–

Laminate flooring with integrated sound-absorbing cushion

	Installation on MEISTER Twin Control m ² K/W	Installation with 0.2 mm MEISTER PE film m ² K/W
LL 150 S	–	0.075
LC 55 S / LD 55 S	–	0.07

Structure of the floating installation

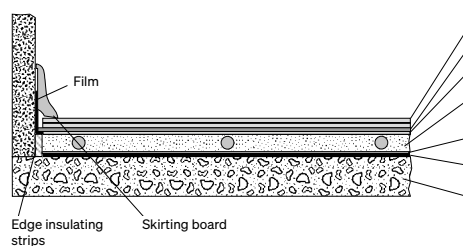

Collections:

Laminate LC 55, LD 55, LC 150, LD 200, LD 150, LB 150, LL 150, LL 250, LD 250, LS 350

Laminate LC 55 S, LD 55 S, LL 150 S, LL 250 S

1. Floor plank	Floor plank with sound-absorbing cushion
2. Silence 20 3. 0.2 mm PE film	Meister PE film
or Twin Control or Silence 15 DB or Silence 25 DB	
4. Screed with installed heating pipes	Screed with installed heating pipes
5. PVC film	PVC film
6. Insulation	Insulation
7. Raw concrete	Raw concrete

MEISTER flooring on controlled hot-water underfloor heating with cooling function

The entire MEISTER flooring range is suitable for installation over controlled hot water underfloor heating with a cooling function. On hot days, these systems can make spaces more comfortable, but they are not a replacement for conventional air conditioning systems.

The following measures and features must be observed for hot water underfloor heating with cooling function:

- | As a general rule: the lower the thermal resistance of the flooring system, the better suited the flooring system is for use on a heated subfloor. The thermal resistance for the entire flooring system has to be calculated as the sum of the thermal resistance of all layers (generally: water-resistant barrier + insulating underlay + flooring). The maximum thermal resistance of the flooring system is 0.15 m²K/W.
 - | For unhindered cooling transfer, floor surfaces should not be covered with carpets or similar items.
 - | The relative humidity on the surface of the cooled floor must not exceed 75% in the short term or 65% in the long term.
 - | For cooling, the initial temperature must be at least 20°C and 3 Kelvin above the dew point temperature of the environment in the room in question.
 - | The maximum surface temperature must not exceed 29° C.
 - | The temperature and relative humidity must be monitored with sensors throughout the year in order to ensure that the underfloor heating/cooling system is functioning properly. The sensors should be installed near the flooring, appropriate to the setup of the room. More than one sensor may be required, depending on the size of the room.
 - | MEISTER parquet, Lindura and wood floorings should be completely glued down in order to optimise the passage of heat. Other MEISTER floorings can also be installed floating according to their installation instructions.
- | To keep the seasonal differences in relative humidity as low as possible, the relative humidity should also be >40% during the heating period. The use of a humidifier to maintain an optimum relative humidity is recommended.
 - | For checking and controlling the current climatic conditions, the installation of a temperature and humidity data logger (e. g. fidbox®) is recommended.
 - | A room temperature of approx. 18–22° C and a relative humidity of approx. 30–65 % are the basis for a healthy room climate.
 - | The respective cleaning and care instructions must always be followed.

Potential risks and damage if the above points are not observed:

- | Deformation and cupping of the individual planks
 - | Formation of joints between the plank rows and in the area of the head joints
 - | Delamination/detachment of the covering layers
 - | Dew point/condensation formation and resulting damage to the subfloor (screed)
- Any temperature-controlled room requires planning and coordination of the heating/cooling system, the screed and the various coverings, taking into account the type of use, in order to ensure optimum and fault-free functionality over the long term. When these special floor constructions are installed, professional standards are correspondingly important. Supplies and processing steps must comply with the generally recognised rules of technology, the briefing sheets available from the central association of the German construction trade, and the assembly and installation guidelines of the relevant system suppliers and manufacturers. Corresponding information is available from the interface coordination supplied by the German Federal Association of Surface Heating and Surface Cooling e.V. (BVF).

Important: The above points must be carried out according to the relevant rules and/or confirmed by specialists (architect, heating specialist etc.). Further information can be found in the standards DIN EN 1264, DIN EN 15377 and DIN EN 12831 as well as in the interface coordination supplied by the German Federal Association of Surface Heating and Surface Cooling e.V. (BVF).

MEISTER flooring over electrical underfloor heating systems

All MEISTER floors can be laid over electrical auxiliary heating and surface heating systems with a performance of 125 W/m². These heating systems have to be able to deliver this performance evenly over the entire surface. Heating systems such as these are not suitable for installation in humid rooms.

The technical briefing sheets from both MEISTER and the respective surface heating manufacturer – as well as the current applicable standards and regulations – must be followed carefully. If the heating mats are approved by the manufacturer for full-surface bonding, the installation and adhesive recommendations of the adhesive manufacturer must also be observed.

The floor must be installed in accordance with the manufacturer's specifications and adapted for the application. The requirements in accordance with VOB Part C, DIN 18356 'Laying of parquet' or DIN 18365 'Flooring works', and the generally recognised rules of technology apply.

MEISTER flooring requires a permanent living climate of approx. 30 – 65 per cent relative humidity at a room temperature of approximately 20° C. If you notice or expect a much lower level of humidity, we recommend the use of a humidifier (vaporiser). This will prevent the MEISTER flooring from drying out excessively.

A thermostat and temperature sensor must be installed according to the manufacturer's instructions to ensure the surface temperature of 29 °C is not exceeded.

All types of wood are suitable; however, significant natural swelling and shrinking can occur depending on the climatic conditions within the room.

The flooring must not be covered with items such as carpets, runners, mats or any other overlays, as these may cause an accumulation of heat.

fidbox®

Humidity and fluctuations in temperature can influence how long a floor lasts and retains its value. We therefore recommend using a fidbox® (a measuring device from floorprotector), which can take long-term data recordings for temperature (°C) and relative humidity (%) in the immediate vicinity of the floor, which can be read using a reading device. In the event of a claim for damage, this can be clarified quickly using the results to prevent any protracted research into the causes.

Full-surface bonding with parquet flooring, Lindura wood flooring and wood flooring Natureflex

The MeisterParquet, longlife parquet flooring, Lindura wood flooring and wood flooring Natureflex can also be installed with full-surface bonding using an approved adhesive as an alternative to floating installation.

Please note that all installation instructions for Mastercllic Plus, Multiclic and UniZip connections must be followed carefully at all times as well as the general recommendations / TKB briefing sheets and preparatory measures explained in the installation instructions when installing flooring with full-surface bonding.

MEISTERWERKE recommends a water-free, shear-resistant adhesive released by the adhesive manufacturer ('Hard' according to ISO 17178).

If you require more information, please contact the corresponding adhesive manufacturer.

Information on adhesives:

The recommendations for adhesives are based on extensive tests conducted by the manufacturers. Due to the variability of on-site conditions, it is not possible to establish warranty claims based on the information provided. We cannot assume liability for any losses incurred in using the adhesive system. For that reason, we recommend that you test the adhesive yourself thoroughly before installing flooring or contact the adhesive manufacturer's technical customer service.

Installation method:

With the floors mentioned, lay each plank individually in the fresh adhesive bed. Then press them down well so that the backs of the planks are covered as thoroughly as possible. To avoid hollow spots, extra weight can also be applied to the planks using a suitable material.

Please note all of the adhesive manufacturer's instructions such as those on hardening and working time.

According to DIN 18365 and 18356, the subfloor for flooring or parquet must always be smooth, dry, clean, free of cracks and release agents, and able to withstand lifting and pressing force.

CM moisture content with screed:

Cement screed: 2.0 CM% (with underfloor heating: 1.8 CM%)

Anhydrite screed: 0.5 CM% (with underfloor heating: 0.3 CM%)

The limit values when carrying out the CRH method are 80 per cent relative humidity for unheated screeds and 75 per cent relative humidity for heated screeds (TKB briefing sheet 18; DIN EN 17668).

(The moisture content limits also apply to fast-hardening cement and screed with screed additives – TKB briefing sheet 14.)

The contractor responsible for laying the flooring/parquet must ensure that subfloor material is inspected for technical suitability. This inspection must take place in accordance with the recognised rules of the trade and current technology, and in compliance with the German Construction Contract Procedures (Vergabe- und Vertragsordnung für Bauleistungen – VOB). If the subfloor reveals deficiencies or there is a risk of damage occurring to the construction of the flooring, the contractor must report these concerns in writing, particularly in the following cases:

- | Serious unevenness
- | Cracks in the subfloor
- | Insufficiently dry subfloor
- | Insufficiently firm subfloor
- | Contaminated subfloor, e.g. oil, wax, lacquer, paint residues

- | Subfloor not being level with adjoining structures
- | Unsuitable subfloor temperature
- | Unsuitable room climate
- | No documentation on heating characteristics for heated flooring constructions
- | Required secure locking of expansion joints in the subfloor
- | No edging strip projection
- | No marking of measurement points for heated flooring constructions
- | No joint layout (if necessary)

fidbox®

Humidity and fluctuations in temperature can influence how long a floor lasts and retains its value. We therefore recommend using a fidbox® (a measuring device from floorprotector), which can take long-term data recordings for temperature (°C) and relative humidity (%) in the immediate vicinity of the floor, which can be read using a reading device. In the event of a claim for damage, this can be clarified quickly using the results to prevent any protracted research into the causes. Further information is available from MEISTERWERKE.

Full-surface bonding with **MeisterDesign. pro** design flooring

MeisterDesign. pro is a high-quality design flooring for full-surface bonding. Strong workmanship and product-specific knowledge are required for installation.

General information:

The subfloor must be prepared in accordance with VOB DIN 18 365. The relevant information sheets such as TKB information sheet no. 8 'Beurteilen und Vorbereiten von Untergründen für Bodenbelag- und Parkettarbeiten' (Evaluation and preparation of subfloors for flooring and parquet work) must be observed. With regard to the required level of subsurface evenness, we recommend consulting technical information sheet no. 02 from the Zentralverband für Parkett und Fußbodentechnik (Central Association for Parquet Flooring and Flooring Technology) and the BEB (Federal Association of Screed and Floor Covering).

MEISTERWERKE recommends a low-emission and solvent-free adhesive (RAL - Blue Angel or EC1) used with a system-specific subfloor preparation.

In order to achieve optimal coverage of the back and secure adherence, it is vital to follow the instructions provided by the adhesive manufacturer regarding processing requirements, notched adhesive comb, application amounts and working times. Special approval from the adhesive manufacturer is required when using contact adhesive or reaction resin adhesive.

After laying the covering in the adhesive bed, every plank must be pressed down with a scraping cork / handle scraper, and rolled with a heavy roller (min. 50 kg).

If you require more information, please contact the corresponding adhesive manufacturer.

Information on adhesives:

The recommendations for adhesives are based on extensive tests conducted by the manufacturers. Due to the variability of on-site conditions, it is not possible to establish warranty claims based on the information provided. We cannot assume liability for any losses incurred in using the adhesive system. For that reason, we recommend that you test the adhesive yourself thoroughly before installing flooring or contact the adhesive manufacturer's technical customer service.

According to DIN 18365 and 18356, the subfloor for laying flooring must always be smooth, dry, clean, free of cracks and release agents, and able to withstand lifting and pressing force.

CM moisture content with screed: Cement screed:
2.0 CM% (with underfloor heating: 1.8 CM%)
Anhydrite screed: 0.5 CM% (with underfloor heating: 0.3 CM%)

The limit values when carrying out the CRH method are 80 per cent relative humidity for unheated screeds and 75 per cent relative humidity for heated screeds

(TKB briefing sheet 18; DIN EN 17668).

The moisture content limits also apply to fast-hardening cement and screed with screed additives – TKB briefing sheet 14.

The contractor responsible for laying the flooring/parquet must ensure that subfloor material is inspected for technical suitability.

This inspection must take place in accordance with the recognised rules of technology and in compliance with the German Construction Contract Procedures (Vergabe- und Vertragsordnung für Bauleistungen – VOB). If the subfloor reveals deficiencies or there is a risk of damage occurring to the construction of the flooring, the contractor must report these 'concerns' in writing, particularly in the following cases:

- | Serious unevenness
- | Cracks in the subfloor
- | Insufficiently dry subfloor
- | Insufficiently firm subfloor
- | Contaminated subfloors, e.g. oil, wax, lacquer, paint residues
- | Subfloor not being level with adjoining structures
- | Unsuitable subfloor temperature
- | Unsuitable room climate
- | No documentation on heating characteristics for heated flooring constructions
- | Required secure locking of expansion joints in the subfloor
- | No edging strip projection
- | No marking of measurement points for heated flooring constructions
- | No joint layout (if necessary)

Cleaning and care agents

Overview of the use of the care products

	Cleaning after completion of construction work / Day-to-day cleaning	Freshening care	Special cleaning
MEISTER parquet flooring, Lindura wood flooring and wood flooring Natureflex			
naturally oiled	Dr. Schutz Premium Wood Soap or Dr. Schutz Premium Wood Soap white* MR: 1:200 In areas with heavy wear / commercial areas: First cleaning Dr. Schutz Premium Care Oil or Dr. Schutz Premium Care Oil white* MR: undiluted	In areas with heavy wear / commercial areas: Dr. Schutz Premium Care Oil or Dr. Schutz Premium Care Oil white* MR: undiluted	Dr. Schutz Deep Clean for hard floors MR: 1:1 to 1:3
lacquered / matt lacquered	Dr. Schutz Wood and Cork Floor Cleaner MR: 1:200	Dr. Schutz Wood and Cork Floor Polish Matt / MR: undiluted	Dr. Schutz Deep Clean for hard floors MR: undiluted
ultra matt lacquered	Dr. Schutz Wood and Cork Floor Cleaner MR: 1:200	Dr. Schutz Wood and Cork Floor Polish Matt / MR: undiluted**	Dr. Schutz Deep Clean for hard floors MR: undiluted

MEISTER design flooring

1. Cleaning after completion of construction work: Dr. Schutz PU Cleaner MR: 1:10	Dr. Schutz Full Care Matt MR: undiluted	Dr. Schutz Deep Clean for hard floors MR: 1:1 to 1:3
2. Day-to-day cleaning: Dr. Schutz PU Cleaner MR: 1:200		

MEISTER laminate flooring

Dr. Schutz Laminate Cleaner MR: 1:200	Dr. Schutz Elatex Stain Remover MR: undiluted
--	--

MR = mixing ratio

* for white oiled floors whose pores and/or surfaces are to be lightened in general:

PD 400, Authentic off-white oak 09031

HD 400 Natural shell white oak 08910

** When using Dr. Schutz Wood and Cork Floor Polish Matt you may increase the gloss level of the surface.

For this reason, we recommend to try the cleaning agent out in an inconspicuous place or on a left-over plank first.

Cleaning and care agents

Quality does not simply stop once the installation is complete.

You have invested in a premium product of German-made quality. These cleaning and care instructions will provide you with all the information you need to preserve both the value and the beautiful appearance of your flooring for the long term. With a bit of time and effort, you can contribute to ensuring that you are able to enjoy your new MEISTER flooring for a long time to come.

MEISTER products are based on selected materials, which are processed by experienced experts with state-of-the-art technology to create a premium product of German quality. This premium quality also includes expert consultation and an excellent all-round service. For this reason, you will only find MEISTER products in selected specialist shops.

1. The right care

Your dream floor also needs the right care. MEISTER complements its product range with a high-quality series of care products from Dr. Schutz. Cleaners and care products, tailored for the floorings, ensure that your floor looks good in the long term. Even if you only need to run the vacuum round for day-to-day care (to remove loose dust), the surfaces should be cleaned and cared for regularly with Dr. Schutz care products to preserve the value of your floor. When cleaning, please ensure that the floor is never completely saturated. In the ideal case, it should only ever be damp mopped so that any moisture dries out after about a minute. Some types of wood, such as beech or maple, are particularly sensitive to moisture.

You should not use any abrasive cleaners, even in case of more severe stains. Even for stubborn stains and dirt, the Dr. Schutz Elatex Stain Remover* will help.

Scratches on the floor not only affect the overall appearance, but they will also make the floor more prone to dirt and moisture. The Dr. Schutz care products are designed to ensure that the floor is considerably more resistant to signs of wear and tear in heavy wear areas. Specialist retailers will also be able to provide you with more tips on how to care for your MEISTER flooring in the best possible way.

2. Value preservation / Precautionary measures

A room temperature of approx. 18–22°C and a relative air humidity of approx. 30–65 per cent will contribute to your personal well-being and are the basis for a healthy room climate. This type of room climate helps to ensure the optimal conditions for your MEISTER flooring, as it reacts to its climatic surroundings like any other wooden material.

Low air humidity with a high temperature will lead to a contracting process in the wood, which dries the floor out. If you determine an air humidity that is considerably lower than 30 per cent in the long term, we recommend the use of air humidifiers (vaporisers). This will prevent your MEISTER flooring from drying out excessively. As with all wooden products, very high air humidity will cause absorption of humidity, which can lead to the length and thickness increasing.

Cracks, open joints, creaking noises, cupping, etc. can be caused by strong fluctuations in room temperature and humidity as well as too low or too high humidity and are not a quality defect.

Introduction of dirt:

Most dirt is brought into your home from the outside and transferred onto the flooring. For this reason, we recommend installing a sufficiently large entrance covering (such as a doormat) in the entrance. Do not use any rubber-coated mats, since prolonged contact can lead to permanent discolouration. Please consider that dirt, such as sand or small stones, will act like sandpaper on all floorings and can lead to unsightly scratches. To protect the wood from scratches, you should also fit chair and furniture feet with felt sliders; office chairs, mobile containers, etc., on castors must be equipped with soft, standard running surfaces (type w). Coloured rubber, natural rubber or plastic glides and castors, as well as dark car, bike or equipment tyres, may possibly cause discolouration on design flooring. Please only use light, non-migrating furniture glides, castors or tyres, if possible. We recommend protecting the floor in these heavy-wear areas with appropriate floor protection mats (e.g. polycarbonate mats). Flower pots/planters made of terracotta or clay can also cause discolouration. Please use suitable, non-migrating mats.

Cleaning and care agents

3. Cleaning after completion of construction work

Newly laid MEISTER floors must be cleaned after completion of construction work and before first use in order to completely remove any dirt or glue residue that has collected during the course of the installation.

You should clean **MEISTER laminate flooring** after completion of construction work with Dr. Schutz Laminate Cleaner*, diluted with water in a ratio of 1:200.

You should clean **ultra matt lacquered MEISTER parquet flooring, MEISTER Lindura wood flooring and MEISTER wood flooring Natureflex** after completion of construction work with Dr. Schutz Wood and Cork Floor Cleaner*, diluted with water in a ratio of 1:200.

You should clean **naturally oiled MEISTER parquet flooring and MEISTER Lindura wood flooring** after completion of construction work with Dr. Schutz Premium Wood Care*, diluted with water in a ratio of 1:200. The flooring has been treated ready for residential use. In **commercial areas and areas that are particularly highly frequented** (such as hallways, kitchens, dining rooms, open living areas with direct exit, and for Lindura wood flooring HD 400 and MeisterParquet. longlife PD 400 in humid rooms (bathrooms)), **subsequent** treatment with Dr. Schutz Premium Care Oil is necessary. Apply the care oil in accordance with the manufacturer's instructions. Once dry (after at least 12 hours), the floor can be used again and damp mopped after allowing it to completely harden for 7 days.

You should clean **MEISTER design flooring** after completion of construction work with Dr. Schutz PU Cleaner*, diluted with water in a ratio of 1:10. Clean the floor using a well wrung out mop and then neutralise with clear water.

The floor is damp mopped using the relevant cleaning solution and a **lint-free** mop or cloth.

**Water-based care products (e.g. polymer dispersions) or Dr. Schutz Elatex Stain Remover can penetrate the seams of the planks in the case of improper adhesion or incomplete jointing, leading to swelling of the base material.*

4. Day-to-day cleaning

MEISTER laminate flooring

To remove daily dirt, vacuuming or sweeping is sufficient. For conventional mopping, Dr. Schutz Laminate Cleaner*, diluted with water in a ratio of 1:200, can be used occasionally. The floor should be damp mopped using a lint-free cloth that has been dipped in this solution and wrung out well. Remove stains, smears and other bonded dirt with Dr. Schutz Elatex Stain Remover* or undiluted Dr. Schutz Laminate Cleaner* and a non-scratch, white pad. Then damp mop using a cloth or mop until the dirt and cleaning agent residue is completely removed.

Ultra matt lacquered MEISTER parquet flooring, MEISTER Lindura wood flooring and MEISTER wood flooring Natureflex

To remove daily dirt, vacuuming or sweeping is sufficient. Depending on the frequency and level of dirt, dilute Dr. Schutz Wood and Cork Floor Cleaner* with water in a ratio of 1:200. The floor should be damp mopped using a lint-free cloth that has been dipped in this solution and wrung out well. Remove fatty stains and other bonded dirt with undiluted Dr. Schutz Wood and Cork Floor Cleaner* and a non-scratch, white pad. Then damp mop with clear water until the dirt and cleaning agent residue is completely removed. Problem stains can be removed with Dr. Schutz Deep Clean*.

We recommend refreshing the floor with Dr. Schutz Wood and Cork Floor Polish Matt to preserve its quality and at the first sign of wear.

Note: When using Dr. Schutz Wood and Cork Floor Polish Matt you may increase the gloss level of the surface. For this reason, we recommend to try the cleaning agent out in an inconspicuous place or on a left-over plank first.

In areas subject to heavier levels of dirt or to build up resistance to wear, first carry out a deep clean with undiluted Dr. Schutz Deep Clean and a green pad. After the floor has dried completely, apply undiluted Dr. Schutz Wood and Cork Floor Polish Matt* very thinly and evenly with a non-lint mop. Leave the floor to dry for at least 12 hours before use.

For the aforementioned deep clean, use the Dr. Schutz Deep Clean* undiluted. Distribute the cleaning solution over the floor in sections using a cloth and then immediately remove any residue of the care product by scrubbing. Make sure that no puddles form. For larger surfaces, use a disk buffing machine with a green pad. Immediately absorb any dirty water completely

with absorbent, dry cloths. Then damp mop with clear water. If possible, carry out the cleaning in pairs so that one person removes the dirt and the other person immediately absorbs any dirty water.

Naturally oiled MEISTER parquet flooring and MEISTER Lindura wood flooring

To remove daily dirt, vacuuming or sweeping is sufficient. For regular cleaning and care, use Dr. Schutz Premium Wood Care* diluted with water in a ratio of 1:200. The floor should be damp mopped using a lint-free cloth that has been dipped in this solution and wrung out well. The floor is cleaned and polished in one work step.

We recommend refreshing the floor with Dr. Schutz Premium Care Oil* to preserve its quality and at the first sign of wear. With normal levels of dirt, clean the floor first using Dr. Schutz Premium Wood Care* diluted with water in a ratio of 1:200 and a green pad.

In cases of heavy soiling or care product build-up, carry out intensive cleaning first using Dr. Schutz Deep Clean* diluted with water in a ratio of 1:1 to 1:3 and a green pad. Distribute the cleaning solution over the floor in sections using a cloth and then immediately remove any residue of the care product by scrubbing. Make sure that no puddles form. For larger surfaces, use a disk buffing machine with a green pad. Immediately absorb any dirty water completely with absorbent, dry cloths. Then damp mop with clear water. If possible, carry out the cleaning in pairs so that one person removes the dirt and the other person immediately absorbs any dirty water. **The flooring must always be re-oiled afterwards using Dr. Schutz Premium Care Oil in accordance with the manufacturer's instructions.** Once dry (after at least 12 hours), the floor can be used again and damp mopped after allowing it to completely harden for 7 days.

Cleaning and care agents

MEISTER design flooring

Loose dust and dirt is removed by vacuuming or sweeping.

Depending on the frequency and degree of dirt, the removal of bonded dirt should be carried out with Dr. Schutz PU Cleaner*, which is diluted with water at a ratio of 1:200. The floor should be damp mopped using a lint-free mop that has been dipped in this solution and wrung out well. Remove stubborn stains and heel marks with undiluted Dr. Schutz PU Cleaner* and a cloth or non-scratch, white pad. Then wipe the floor with clear water. A thorough clean of the floor is required to remove particularly stubborn dirt and residues and to prepare the floor for treatment with a care product in case of visible signs of wear. For this, evenly spray Dr. Schutz Deep Clean* undiluted on the floor and after allowing it to take effect for a short while (max. 5 minutes), scrub with a green pad or scrubbing brush. Wipe away loosened dirt using a cloth and wipe over again using clear water until all dirt and cleaner residue has been completely removed.

Note: If you do not intend to use a care treatment on the flooring afterwards, only use scrubbing brushes instead of green pads. If there are signs of wear on the surface after long or intensive use, this can be refreshed with intensive maintenance after thoroughly cleaning the floor with (Dr. Schutz Deep Clean*). To do this, apply undiluted Dr. Schutz Full Care Matt* thinly and evenly in a lengthwise direction with a lint-free mop rinsed in clear water and wrung out well. When the protective film can be walked on (after 45 minutes), apply a second coating in the crossways direction. Use: 750 ml for approx. 25–35 m² per application. If the protective film is worn away over the course of time, this can be refreshed with intensive maintenance after thoroughly cleaning the floor with Dr. Schutz Deep Clean*. In **commercial properties**, cleaning should always be carried out using a cleaning machine or spray cleaning process with a disk buffing machine, as well as separate value preservation measures. Please contact our technical customer services for further information.

5. General information about cleaning and care

Never leave MEISTER flooring damp or wet over a long period of time. When cleaning, always try to use a dry method if possible (using a mop, broom, vacuum cleaner), or a damp mop (using a wrung-out lint-free cloth) and do not leave any 'puddles' on the flooring. Steam cleaners are not suitable for the flooring. Do not use any scouring creams or powders, as these agents can damage the surface of the flooring. Please only use suitable cleaners. Problem stains on laminate or lacquered parquet and wood flooring can be removed with Dr. Schutz Elatex Stain Remover. Please be aware that you may increase the gloss level on the laminate surface by removing the stain with increased pressure with a white pad. For this reason, try this out in an inconspicuous place or on a left-over plank first.

All kinds of chemicals, such as solvents, antiseptics and disinfectants, hair dye, fats, nail varnish remover, acetone, felt pen or ballpoint ink etc., may cause permanent stains.

**Water-based care products (e.g. polymer dispersions) or Dr. Schutz Elatex Stain Remover can penetrate the seams of the planks in the case of improper adhesion or incomplete jointing, leading to swelling of the base material.*

Longlife warranty on MEISTERWERKE parquet flooring

I. Warranty cover: MeisterWerke Schulte GmbH, Johannes-Schulte-Allee 5, 59602 Rùthen-Meiste, provides a warranty, over and beyond statutory rights under Section 437 of the German Civil Code (replacement, cancellation of contract, reduction of purchase price and compensation), under the following warranty conditions. The aforementioned statutory rights, the use of which is free, are not restricted by this warranty. The parquet's extraordinary durability is achieved by the three-layer structure (fine wood wear layer, middle layer and backing) using a special middle layer made from a high density fibreboard (HDF). Therefore, MEISTERWERKE provides a warranty for the triple-layer product structure's strength with regards to the bonding of individual layers, provided the product is used for the purpose which it is intended in living areas. The warranty does not cover any damage caused by incorrect treatment and use. In particular, any load or wear on the flooring that is not the purpose for which the flooring was intended, mechanical damage caused by furniture, pets, etc., such as dents and scratches. Optical faults such as visual joints, colour changes due to the effects of light, or seasonal, climatic warping of individual planks are also not covered. Damage as a result of insect infestation, improper care, cleaning or maintenance of the surface and surface coating, specifically chemical damage or damage caused by the penetration of moisture is also not included. The warranty applies exclusively to first-choice products and use in private living areas subject to normal wear, with the exception of humid rooms, such as bathrooms or saunas. Special warranty conditions apply for the USA and Canada. This warranty does not apply in said regions.

II. Warranty period: The warranty period for MEISTER parquet flooring is 35 years after the relevant date of purchase.

III. Warranty conditions: The flooring must have been fitted in accordance with the installation instructions enclosed in every third product package or that can be found on the internet at www.meister.com/service in the permitted areas of use named within the instructions. In particular, information in the installation instructions about checking the humidity of subsurfaces and the installation on underfloor heating must be observed. The flooring must also be maintained and cleaned according to the care instructions enclosed with the product. If these installation or care instructions are missing and/or incomplete, the claimant is obliged to request this information from their specialist retailer or directly from MEISTERWERKE before laying the flooring. The installation, cleaning and care instructions can be found at www.meister.com. In addition, it should be noted that the surface coating is a protective layer for the wooden wear layer underneath it and is subject to normal wear. Therefore, the warranty does not cover wearing down of this coating. If signs of wear appear, the surface must be renewed in good time, properly and to the required extent by a specialist company. Therefore, the warranty does not cover damage resulting from incorrect installation, incorrect care or cleaning or a failure to expertly renew the surface coating in good time.

IV. Reporting a warranty claim: Any complaint must be made in text form to MEISTERWERKE (e.g. by post, fax or email), enclosing a copy of the original invoice from the specialist retailer, which serves as a certificate of warranty. If it is not possible to present the original specialist retailer's invoice, any claim under the warranty is excluded. Once the claim is received by

MEISTERWERKE, the company must notify the customer within four weeks whether a warranty claim has been acknowledged. If no notification is given within this period, the warranty claim is deemed to have been rejected. During this period, MEISTERWERKE or a third party employed by them must be granted access to the flooring that is the subject of the complaint on site in order to investigate whether the claim is justified.

V. Scope of the warranty: When a warranty claim is acknowledged, MEISTERWERKE will at their discretion repair the faulty plank or alternatively provide replacement material of the same quality, if at all possible from the same range, for the entire room in which the problem has occurred. The provisions in accordance with Section 439 (2), (3), (5) and (6) sentence 2 and Section 475 (5) of the German Civil Code (BGB) shall apply to this claim.

VI. Limitation of warranty: The warranty period is not extended by a warranty claim. Claims under the warranty expire six months from the date of MEISTERWERKE's receipt of the customer's written complaint (see IV.), but no earlier than the expiry of the warranty period.

VII. Choice of law: This warranty is subject to German law, to the exclusion of the United Nations Treaty governing contracts for the international sale of goods. However, this does not affect the legal provisions regarding the limitation of the choice of law; in particular and in accordance with Art. 6 (2) of EC Regulation (EC) No. 593/2008 (the 'Rome I Regulation'), the beneficiary of the warranty can, irrespective of the choice of law and in accordance with Section 1, invoke the mandatory protection of the law that would apply in the absence of this choice of law.

Warranty on MEISTERWERKE Lindura wood flooring

I. Warranty cover: MeisterWerke Schulte GmbH, Johannes-Schulte-Allee 5, 59602 Rürthen-Meiste, provides a warranty, over and beyond statutory rights under Section 437 of the German Civil Code (replacement, cancellation of contract, reduction of purchase price and compensation), under the following warranty conditions. The aforementioned statutory rights, the use of which is free, are not restricted by this warranty. MEISTERWERKE provides a warranty for the durability of the multilayer product structure relating to pressing and fusing the single layers with one another. The warranty does not cover any damage caused by incorrect treatment and use. In particular, any load or wear on the flooring that is not the purpose for which the flooring was intended, mechanical damage caused by furniture, pets, etc., such as dents and scratches. Optical faults such as visual joints, colour changes due to the effects of light, or seasonal, climatic warping of individual planks are also not covered. Damage as a result of insect infestation, improper care, cleaning or maintenance of the surface and surface coating, specifically chemical damage or damage caused by the penetration of moisture is also not included. The warranty applies exclusively to first-choice products and use in private living areas subject to normal wear up to heavy-wear areas, with the exception of humid rooms, such as bathrooms or saunas, or use in commercial areas with normal wear, e.g. offices, waiting rooms, boutiques etc. (corresponds to the range of application of wear class 32). Special warranty conditions apply for the USA and Canada. This warranty does not apply in said regions.

II. Warranty period: The warranty period is in accordance with the warranty time stated for each individual product and for the concrete type of use described, after the appropriate date of purchase respectively.

III. Warranty conditions: The flooring must have been fitted in accordance with the installation instructions enclosed in every third product package or that can be found on the internet at www.meister.com/service in the permitted areas of use named within the instructions. In particular, information in the installation instructions about checking the humidity of subsurfaces and the installation on underfloor heating must be observed. The flooring must also be maintained and cleaned according to the care instructions enclosed with the product. If these installation or care instructions are missing and/or incomplete, the claimant is obliged to request this information from their specialist retailer or directly from MEISTERWERKE before laying the flooring. The installation, cleaning and care instructions can be found at www.meister.com. In addition, it should be noted that the surface coating is a protective layer for the wooden wear layer underneath it and is subject to normal wear. Therefore, the warranty does not cover wearing down of this coating. If signs of wear appear, the surface must be renewed in good time, properly and to the required extent by a specialist company. Therefore, the warranty does not cover damage resulting from incorrect installation, incorrect care or cleaning or a failure to expertly renew the surface coating in good time.

IV. Reporting a warranty claim: Any complaint must be made in text form to MEISTERWERKE (e.g. by post, fax or email), enclosing a copy of the original invoice from the specialist retailer, which serves as a certificate of warranty. If it is not possible to present the original specialist retailer's invoice, any claim under the warranty is excluded. Once the claim is received by MEISTERWERKE, the company must notify the customer within four weeks whether a warranty claim has been acknowledged. If no notification is given within this period, the warranty claim is deemed to have been rejected. During

this period, MEISTERWERKE or a third party employed by them must be granted access to the flooring that is the subject of the complaint on site in order to investigate whether the claim is justified.

V. Scope of the warranty: When a warranty claim is acknowledged, MEISTERWERKE will at their discretion repair the faulty plank or alternatively provide replacement material of the same quality, if at all possible from the same range, for the respective room in which the problem has occurred. The provisions in accordance with Section 439 (2), (3), (5) and (6) sentence 2 and Section 475 (5) of the German Civil Code (BGB) shall apply to this claim.

VI. Limitation of warranty: The warranty period is not extended by a warranty claim. Claims under the warranty expire six months from the date of MEISTERWERKE's receipt of the customer's written complaint (see IV.), but no earlier than the expiry of the warranty period.

VII. Choice of law: This warranty is subject to German law, to the exclusion of the United Nations Treaty governing contracts for the international sale of goods. However, this does not affect the legal provisions regarding the limitation of the choice of law; in particular and in accordance with Art. 6 (2) of EC Regulation (EC) No. 593/2008 (the 'Rome I Regulation'), the beneficiary of the warranty can, irrespective of the choice of law and in accordance with Section 1, invoke the mandatory protection of the law that would apply in the absence of this choice of law.

Warranty of wear resistance for MEISTERWERKE wood flooring

I. Warranty cover: MeisterWerke Schulte GmbH, Johannes-Schulte- Allee 5, 59602 Rürthen-Meiste, provides a warranty, over and beyond statutory rights under § 437 of the German Civil Code (replacement, cancellation of contract, reduction of purchase price and compensation) under the following warranty conditions. The aforementioned statutory rights, the use of which is free, are not restricted by this warranty. A warranty is provided to ensure that the veneer layer on the purchased product will not wear away within the warranty period provided the product is used properly for the purpose intended, according to the following warranty conditions. Any spot on which the veneer layer has been removed down to the base material over an area of at least 1 cm² is regarded as having worn away, though signs of wear on the edge area of an individual floor plank are excluded from this warranty. The warranty does not cover any damage caused by incorrect treatment and use. In particular, any load or wear on the flooring that is not the purpose for which the flooring was intended, mechanical damage caused by furniture, pets etc. such as dents and scratches, for example. Visual damage such as joints, changes in colour due to exposure to light and the deformation of individual planks caused by seasonal room climate conditions are also not covered. Damage as a result of insect infestation, improper care, cleaning or maintenance of the surface and surface coating, specifically chemical damage or damage caused by the penetration of moisture is also not included. The warranty applies exclusively to first choice products and use in private living areas or commercial areas depending on the wear class specified, with the exception of humid rooms, such as bathrooms or saunas. The warranty also applies to use in humid rooms such as bathrooms at Natureflex wood flooring HD 100. Use in wet rooms, such as showers, public washrooms and saunas, is not permitted. Special warranty conditions apply for the USA and Canada. This warranty does not apply in said regions.

II. Warranty period: The warranty period is in accordance with the warranty time stated for each individual product and for the concrete type of use described, after the appropriate date of purchase respectively.

III. Warranty conditions: The flooring must have been fitted in accordance with the installation instructions enclosed in every third product package or that can be found on the internet at www.meister.com/service in the permitted areas of use named within the instructions. In particular, information in the installation instructions about checking the humidity of subsurfaces and the installation on underfloor heating must be observed. The floor must also be maintained and cleaned according to the care instructions enclosed with the product. If these installation or care instructions are missing and/or incomplete, the claimant is obliged to request this information from their specialist retailer or directly from MEISTERWERKE before fitting the flooring. The installation, cleaning and care instructions can be found at www.meister.com. In addition, it should be noted that the surface coating is a protective layer for the wooden wear layer underneath it and is subject to normal wear. Therefore, the warranty does not cover wearing down of this coating. If signs of wear appear, the surface must be renewed in good time, properly and to the required extent by a specialist company. Therefore, the warranty does not cover damage resulting from incorrect installation, incorrect care or cleaning or a failure to expertly renew the surface coating in good time.

IV. Reporting a warranty claim: Any complaint must be made in text form to MEISTERWERKE (e.g. as a letter sent via the postal system, a fax, or an e-mail), enclosing a copy of the original invoice from the specialist retailer, which serves as a certificate of warranty. If it is not possible to present the original specialist retailer's invoice, any claim under the warranty is excluded. Once the claim is received by MEISTERWERKE, it

must notify the customer within four weeks whether a warranty claim has been acknowledged. If no notification is given within this period, the warranty claim is deemed to have been rejected. During this period, MEISTERWERKE or a third party employed by them must be granted access to the flooring that is the subject of the complaint on site in order to investigate whether the claim is justified.

V. Scope of the warranty: When a warranty claim is acknowledged, MEISTERWERKE will at their discretion repair the faulty plank or alternatively provide replacement material of the same quality, if at all possible from the same range, for the respective room in which the problem has occurred. The provisions in accordance with § 439 (2), (3), (5) and (6) sentence 2 and § 475 (5) of the German Civil Code shall apply to this claim.

VI. Limitation of warranty: The warranty period is not extended by a warranty claim. Claims under the warranty expire six months from the date of MEISTERWERKE's receipt of the customer's written complaint (see IV.), but no earlier than the expiry of the warranty period.

VII. Choice of law: This warranty is subject to German law, to the exclusion of the United Nations Treaty governing contracts for the international sale of goods. However, this does not affect the legal provisions regarding the limitation of the choice of law; in particular and in accordance with Art. 6 (2) of EC Regulation (EC) No. 593/2008 (the "Rome I Regulation"), the beneficiary of the warranty can, irrespective of the choice of law and in accordance with Section 1, invoke the mandatory protection of the law that would apply in the absence of this choice of law.

Warranty of wear resistance for MEISTERWERKE design and laminate flooring

I. Warranty cover: MeisterWerke Schulte GmbH, Johannes-Schulte-Allee 5, 59602 Rülthen-Meiste, provides a warranty, over and beyond statutory rights under Section 437 of the German Civil Code (replacement, cancellation of contract, reduction of purchase price and compensation), under the following warranty conditions. The aforementioned statutory rights, the use of which is free, are not restricted by this warranty. A warranty is provided to ensure that the decorative layer on the purchased product will not wear away within the warranty period provided the product is used properly for the purpose intended, according to the following warranty conditions. Any spot on which the decorative layer has been removed down to the base material over an area of at least 1 cm² is regarded as having worn away, though signs of wear on the edge area of an individual flooring plank are excluded from this warranty. Any load on the flooring that is not the purpose for which the flooring was intended, mechanical damage and failure to comply with the MEISTERWERKE care instructions for the respective flooring exclude any claim under the warranty. The warranty applies exclusively to first-choice products and use in private living areas or commercial areas depending on the wear class specified, with the exception of humid rooms, such as bathrooms or saunas. The warranty also applies to use in humid rooms such as bathrooms with MeisterDesign. allround, MeisterDesign. pro, MeisterDesign. comfort, MeisterDesign. flex, Meister Design. next, MeisterDesign. rigid, Meister Design. laminate LL 250, LL 250 S, LD 250, LL 150, LL 150 S, LB 150, LD 150 and LC 150. Use in wet rooms, such as showers, public washrooms and saunas, is not permitted. Special warranty conditions apply for the USA and Canada. This warranty does not apply in said regions.

II. Warranty period: The warranty period is in accordance with the warranty time stated for each individual product and for the concrete type of use described, after the appropriate date of purchase respectively. If a lifetime guarantee has been issued for use in living areas, this is limited to the normal useful life of the product. This is set at 30 years.

III. Warranty conditions: The flooring must have been fitted in accordance with the installation instructions enclosed in every third product package or that can be found on the internet at www.meister.com/service in the permitted areas of use named within the instructions. In particular, information in the installation instructions about checking the humidity of subsurfaces and the installation on underfloor heating must be observed. The flooring must also be maintained and cleaned according to the care instructions enclosed with the product. If these installation or care instructions are missing and/or incomplete, the claimant is obliged to request this information from their specialist retailer or directly from MEISTERWERKE before laying the flooring. The installation, cleaning and care instructions can be found at www.meister.com.

IV. Reporting a warranty claim: Any complaint must be made in text form to MEISTERWERKE (e.g. by post, fax or email), enclosing a copy of the original invoice from the specialist retailer, which serves as a certificate of warranty. If it is not possible to present the original specialist retailer's invoice, any claim under the warranty is excluded. Once the claim is received by MEISTERWERKE, the company must notify the customer within four weeks whether a warranty claim has been acknowledged. If no notification is given within this period, the warranty claim is deemed to have been rejected. During

this period, MEISTERWERKE or a third party employed by them must be granted access to the flooring that is the subject of the complaint on site in order to investigate whether the claim is justified.

V. Scope of the warranty: When a warranty claim is acknowledged, MEISTERWERKE will at their discretion repair the faulty plank or alternatively provide replacement material of the same quality, if at all possible from the same range, for the respective room in which the problem has occurred. The provisions in accordance with Section 439 (2), (3), (5) and (6) sentence 2 and Section 475 (5) of the German Civil Code (BGB) shall apply to this claim.

VI. Limitation of warranty: The warranty period is not extended by a warranty claim. Claims under the warranty expire six months from the date of MEISTERWERKE's receipt of the customer's written complaint (see IV.), but no earlier than the expiry of the warranty period.

VII. Choice of law: This warranty is subject to German law, to the exclusion of the United Nations Treaty governing contracts for the international sale of goods. However, this does not affect the legal provisions regarding the limitation of the choice of law; in particular and in accordance with Art. 6 (2) of EC Regulation (EC) No. 593/2008 (the 'Rome I Regulation'), the beneficiary of the warranty can, irrespective of the choice of law and in accordance with Section 1, invoke the mandatory protection of the law that would apply in the absence of this choice of law.

© 2024 by MeisterWerke Schulte GmbH

For reasons of printing technology, colours and structures may vary from the reproductions shown here.
We reserve the right to make changes. No responsibility is assumed for errors.

MEISTER – a trademark of MeisterWerke Schulte GmbH

Johannes-Schulte-Allee 5 / 59602 Rùthen-Meiste, Germany

Phone +49 2952 816-0 / Fax +49 2952 816-66 / www.meister.com

EN

04/24